

Choosing the correct detector for your specific application involves many criteria. No single table or graph can uniquely specify a detector for a particular measurement. The recommendations that follow are intended to guide a user to the detector likely to be best suited for the application. (If you have questions about whether a particular detector's performance will meet your needs, we suggest that you contact your local sales representative or the ORTEC facility in Oak Ridge, Tennessee, USA.)

To choose the optimum detector to solve a particular measurement problem, several issues should be considered.

HPGe Detector Types

All HPGe radiation detectors are large, reverse-biased diodes. The germanium material can be either "P-type" or "N-type". The type depends on the concentration of donor or acceptor atoms in the crystal. To connect the diode to an electrical circuit to amplify the signal, we need to put contacts on the crystal. These electrical contacts on the crystal are a thick, lithium diffused contact, which is the N+ contact, and a thin, ion-implanted contact, which is the P+ contact.

Exceptions are the GEM-FX and GEM-MX detectors in which the front contact has a thinner layer of lithium diffusion.

The crystal can be cut or ground to any shape. However, the electrical field inside the crystal (diode) is very important. This limits the useful shapes to a disk or a cylinder with a hollow core. The cylinders are closed at one end and called coaxial; the disks are called planar. These are shown in Fig. 1.

Depending on the type of material used (N or P), the contacts are applied differently. For P-type material, the thick, lithium diffused contact is on the outer surface and the thin, ion-implanted contact is on the inside. The ORTEC name is GEM. For N-type material the contacts are reversed. The ORTEC name is GMX. Very short coaxial detectors are called LO-AX detectors. Figure 2 shows the two N-types detectors: GMX and LO-AX. Coaxial construction allows larger (deeper) detectors to be fabricated, but the large size means a higher capacitance. The higher capacitance increases the resolution, which means there is a tradeoff to be made between having the best low-energy resolution and having the highest efficiency at higher energies. The ORTEC LO-AX geometry is a semi-planar (or maybe a semi-coaxial) geometry, with a good low energy resolution and better high energy efficiency (deeper) than a planar.

The P-type coaxial (GEM) is the most commonly used HPGe in counting laboratories. The N-type coaxial (GMX) has extended low-energy efficiency because of the thin contact and has slightly worse resolution specifications at higher energies than a GEM. The largest GEM detectors are about 75% higher than the largest GMX. LO-AX and planar (GLP) detectors have excellent low-energy resolution, but reduced high-energy efficiency and resolution.

How Do You Select the Detector?

First, let us present some measurements made on different types of detectors to show several features. We will show you how to select the right detector for your application. The right detector is the detector that produces the most analyzable data in the shortest time for the lowest cost. Most spectroscopy problems can be solved with simple detectors. There is no need to have exotic or overly complex designs.

The Analyzable Spectrum: Good Data vs. BAD Data

"Good data" is defined as being spectral data in which the peaks of interest are well shaped and have good "signal to noise." This is a key consideration; just having more data doesn't make the data better.

One measure of the quality of a spectrum is the minimum detectable activity (MDA) of the detector system. The resolution, background and efficiency of the detector are related to the MDA. This relationship may be simply stated as (Ref. 2):

$$MDA(E) \sim \text{SQRT} [R(E) B(E)] / \epsilon(E) \frac{\sqrt{R(E) B(E)}}{\epsilon(E)} \quad (1)$$

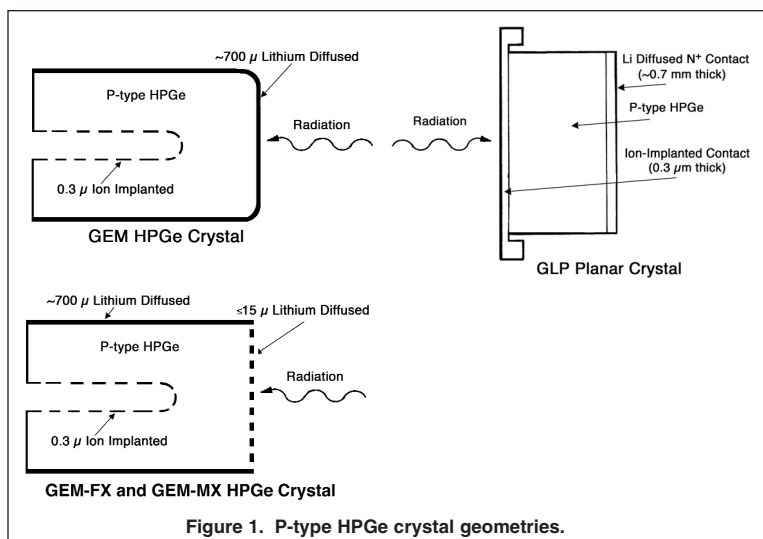

Figure 1. P-type HPGe crystal geometries.

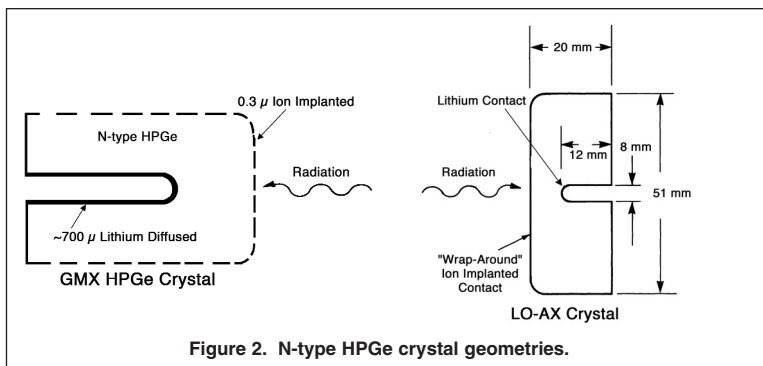

Figure 2. N-type HPGe crystal geometries.

How to Choose the Right Photon Detector for Your Application

The MDA varies with energy because the quantities on which it depends vary with energy. Here we have separated out all the factors in the MDA that only depend on the detector itself. The gamma rays per decay, the shield and count time affect the MDA, but will do so in the same way for all detectors.

$R(E)$ is the energy resolution of the detector as a function of energy; $B(E)$ is the background counts per keV (unit energy) as a function of energy and $\epsilon(E)$ is the absolute efficiency of the detector as a function of energy.

This simple formula is highly significant in guiding us towards the right choice of detector. Let us examine it in more detail.

You can see that the MDA is linear in efficiency, but proportional to the square root of the resolution and the background. So you would expect that the biggest detector will give the best MDA for a low-activity sample. Is it always the case that "Bigger is Better" (Ref. 3)? Yes and no! More efficiency will always improve the detection limit reached in a given count time. However, you should consider the sample to be counted:

- Does the spectrum have interferences (multiplets) in which a gamma-ray peak of interest is obscured by a peak from another nuclide? Equation 1 is correct, but the resolution of a larger detector is typically worse than the resolution of a smaller detector. This could mean that a good resolution detector will give better MDAs than a larger efficiency detector.
- Does background increase as relative efficiency increases? Certainly, as the efficiency increases, the background increases, but data from a large number of all sizes of detectors shows clearly that the background increases less rapidly than the efficiency. Thus MDA improves on larger detectors. (Fig. 3) Cosmic background will also increase with increasing detector size, but will increase no faster than efficiency and thus MDA will improve. This background is the general background in the detector when no sample activity is present. As soon as a sample source with non-zero activity is presented to the detector, this will also add to the general background in the form of source induced background.

As detectors increase in size (efficiency), the peak-to-Compton ratio (p/C) increases, (Fig. 4) which means that the ratio of source related signal to source induced background in the spectrum will increase, that is improve (Fig. 4). Figure 5 shows an example of this. Two GMX detectors were used to count the same sources in the same geometry. The peak areas for ^{241}Am and ^{137}Cs are shown. The ratios of the counts in the spectra are not as large as the stated efficiency ratio because the stated efficiency is for 1.3 MeV only. The source-induced background is higher for the larger detector (except in the 100 keV region), but the ratio of the two backgrounds is never as high as the efficiency ratio for the peaks. We talked earlier about cosmic and other non-source background. If the Compton background has been produced in the spectrum because of a dense sample matrix, a high p/C detector will not reduce this Compton background. For example, in plutonium-in-human lung measurements, a high contributor to Compton background is the natural ^{40}K gamma rays scattering from the person's bones. This cannot be reduced by the detector.

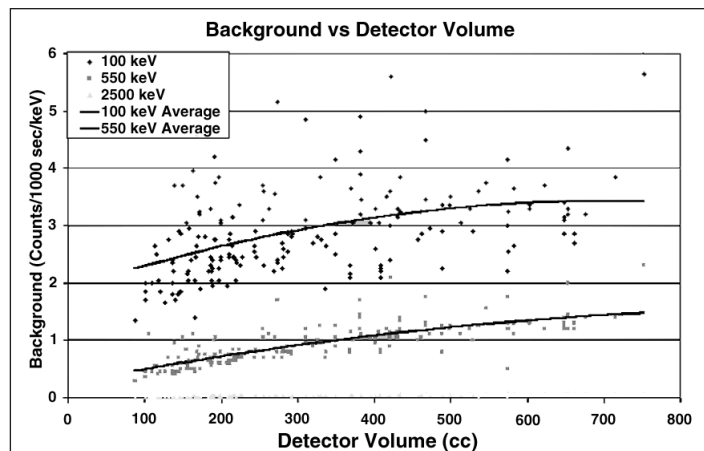

Figure 3. Background counts vs. detector volume for a large number of detectors.

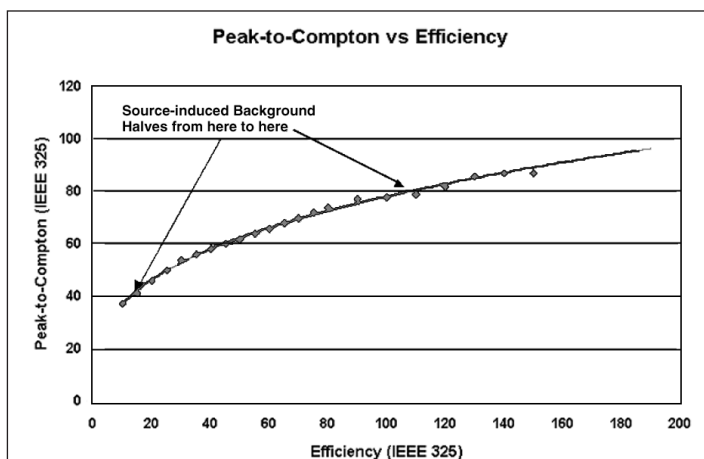

Figure 4. Peak to Compton ratio vs. relative efficiency for coaxial P-type detectors.

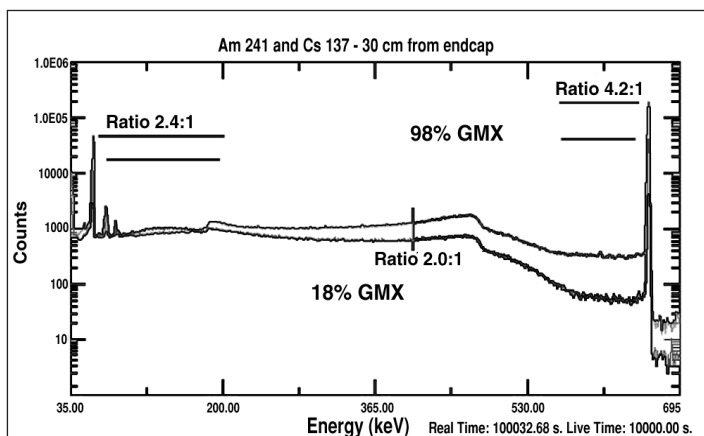

Figure 5. Comparison of $^{137}\text{Cs}/^{241}\text{Am}$ spectra obtained with 18 and 98% relative efficiency GMX detectors, showing the effect of increasing P:C ratio, improving MDA.

How to Choose the Right Photon Detector for Your Application

Is a More Complex Solution Likely to be a Better Solution?

Compton Suppression Systems?

The large Compton background seen in Fig. 5 is due to capturing only part of the original gamma-ray energy. Some of the remaining or lost energy actually leaves the detector. If we could capture these lost energy parts, we could reject the part of the gamma-ray energy captured in the HPGe. In a Compton Suppression System (CSS), (Fig. 6) the HPGe detector is surrounded by a NaI(Tl) annular detector which detects photons escaping from the HPGe. The signals from the HPGe and NaI are used in anticoincidence circuitry to remove the Compton background events from the primary gamma-ray spectrum. CSS systems are usually tested with ^{137}Cs , and some systems have background improvements of a factor of 5 over the p/C ratio of the detector itself.

CSS Advantages: For a given HPGe detector, a CSS will always reduce Compton background. It is also called an "active shield." It reduces the cosmic background because a cosmic ray produces events (counts) in both detectors.

CSS Disadvantages: The sample size is usually small because the sample must be placed inside the NaI annulus. The system is complex: coincidence electronics require careful adjustment and maintenance to ensure consistent performance. CSS efficiency calibration is complex because some nuclides naturally emit photons in coincidence with each other and this reduces the full-energy peak areas for these peaks as well as reducing the background. Most importantly CSS systems are expensive. It is usually better to spend your money on a larger HPGe detector, which may be less expensive, work better, and be simpler than Compton suppressing a smaller detector. Compton suppression of large detectors is not as effective (not as large an improvement) as small detectors because the large detectors already have a high p/C ratio. High p/C HPGe detectors have largely replaced CSS.

Detector Efficiency: $\epsilon(E)$

The detector efficiency in Eq. 1 will potentially have the most effect on MDA.

The IEEE-325 definition of relative efficiency (Ref. 4) at 1.33 MeV, is not a good indicator of detector sensitivity in most of the sample geometries you want to use. It is defined at a single energy and for a point source at 2 cm distance to the detector endcap. No real samples meet these criteria except a point ^{60}Co source at 25 cm from the endcap! On the other hand, relative efficiency is often a good place to start as a general indicator of detector performance. The efficiency for various energies is shown in Figure 7.

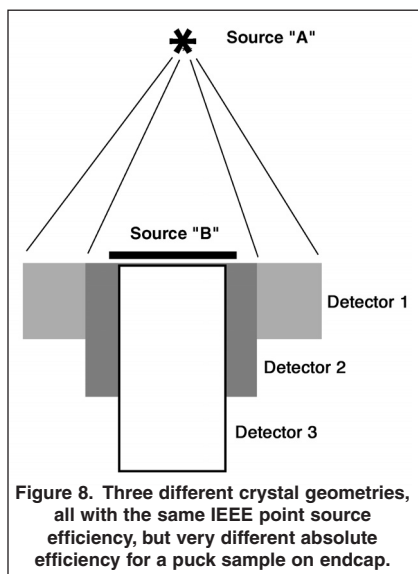

Figure 8. Three different crystal geometries, all with the same IEEE point source efficiency, but very different absolute efficiency for a puck sample on endcap.

In Eq. 1, $\epsilon(E)$ is the absolute efficiency at the specified energy. $\epsilon(E)$ will depend on the detector-to-sample geometry, and many other energy dependent factors, including gamma-ray absorption in matrix and detector dead layers and the intrinsic efficiency of the detector. The IEEE-325 relative efficiency is no longer a suitable indicator.

Figure 8 illustrates how three detectors can have the same IEEE-325 efficiency, yet have different efficiencies for your samples and your nuclides. All three schematically represented detectors have the same IEEE-325 relative efficiency, but for counting a flat disk-like sample (e.g., filter paper), it is obvious that the long and thin detector will have poorer geometrical efficiency than the "shorter and fatter" detectors. So if your samples are filter papers, disks or other large area containers, your best selection will be a shorter and fatter detector, such as the ORTEC PROFILE GEM. With the ORTEC PROFILE GEM series, you can specify the crystal dimensions as well as IEEE-325 relative efficiency (Ref. 7).

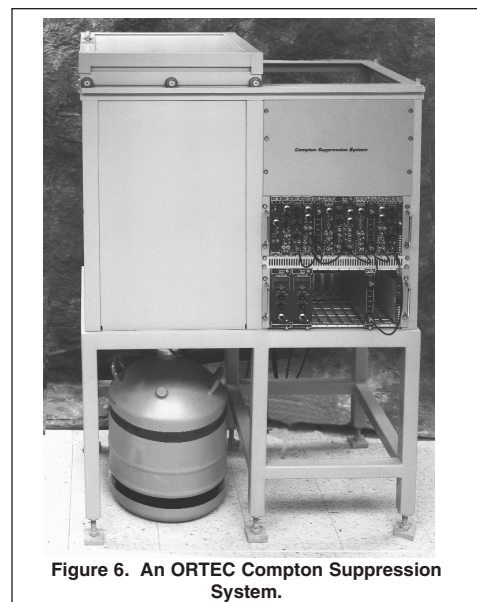

Figure 6. An ORTEC Compton Suppression System.

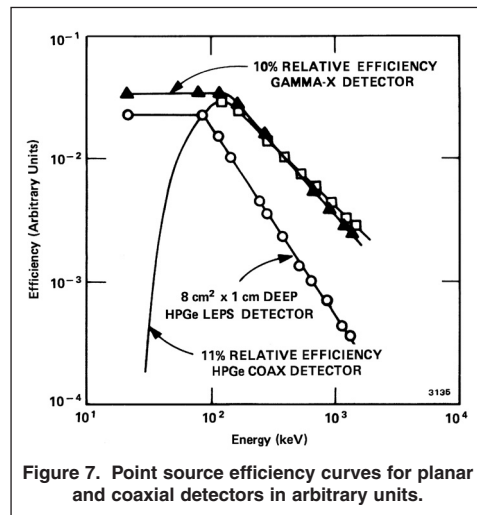

Figure 7. Point source efficiency curves for planar and coaxial detectors in arbitrary units.

How to Choose the Right Photon Detector for Your Application

Dead Layers, Windows and Absorption

Now you need to consider the gamma-ray range of energies to be analyzed. All materials will absorb gamma rays. The materials between the emitting nuclide and the crystal can absorb (or attenuate) the gamma-ray flux. The absorption processes are a function of energy and described by the exponential attenuation equation below:

$$I = I_0 e^{-\mu(E) x} \quad (2)$$

Where I_0 is the unattenuated gamma-ray flux, I is the flux after passing through the material and μ is the linear attenuation coefficient of the absorber and x is the thickness.

This relationship determines both how deep a detector needs to be to stop the incident gamma rays and the reduction in efficiency due to the window thickness and crystal dead layer thickness. The exponential function in the equation means there is no absolute cutoff length for absorption or stopping power, so that a thin planar detector will have reduced, but not zero efficiency at high energy and a thick contact coaxial detector will have reduced and not zero efficiency at low energy. The optimum choice of detector is a tradeoff of all measurement parameters.

Figure 9 compares absolute efficiency of two detectors, one P-type (GEM) and one N-type (GMX). The crystals are of very similar diameter, but the GEM is 14 mm deeper than the GMX. As you look at the efficiency above about 150 keV, there is little difference in efficiency. The efficiency curves are diverging slightly with increasing energy because the deeper GEM crystal will stop more gamma rays. Below 150 keV, the GMX has higher efficiency and below 100 keV, the difference increases rapidly as you go down in energy. This is because the dead layer of the GEM (~700 microns) is much larger than that of the GMX (~0.3 microns). Any gamma rays stopped in the dead layer do not produce an output. At 60 keV (^{241}Am), the GMX has about 1.7 times the absolute efficiency of the GEM and a proportionately better detection limit for ^{241}Am (Eq. 1). This does not mean the GEM cannot measure ^{241}Am , it simply means that it is not as good as the GMX (the thin window PROFILE GEM-MX can provide good efficiency for ^{241}Am). The GMX however would cost significantly more, and for the measurement of higher energy gamma rays, for example, ^{137}Cs at 661 keV, is no better. Don't forget the GEM will have superior resolution and p/C, because it is a P-type and has bigger dimensions. So the GEM will have better MDA at the higher energies.

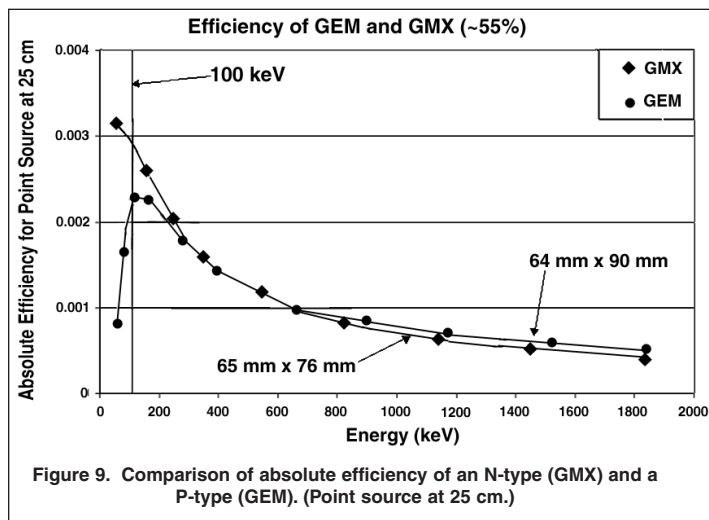

Figure 9. Comparison of absolute efficiency of an N-type (GMX) and a P-type (GEM). (Point source at 25 cm.)

Detector TYPE "Rules of Thumb"

P-type (GEM) vs. N-type (GMX, LO-AX)

~80 keV–3 MeV use a GEM (P-type) Coaxial detector. Why? The GMX has no advantage above 80 keV, costs more and may have poorer resolution.

~10 keV–3 MeV use a GEM-FX or GEM-MX (P-type), or a GMX (N-type) with a Carbon Fiber Window (60% transmission at 10 keV) Beryllium (Be) has 29% higher transmission at 10 keV, but is toxic and fragile.

~3 keV–3 MeV use a GMX (N-type) with a beryllium Window.

Sample Presentation

Samples for gamma-ray spectrometry come in all shapes, sizes, chemical and physical forms. The activity you need to measure may be very low in a large sample, or it may be very high in a small sample or anywhere in between. The matrix of the sample may be dense and have a high atomic number, therefore making accurate measurements difficult due to attenuation of the gamma rays.

You may be able to position the sample relative to the HPGe detector in a way to optimize the spectrum gathered, and therefore the results. You may have external reasons which define or restrict the choice of how the sample is presented to the detector. Some reasons you may see are:

- A human being in a bioassay measurement is a fixed-format sample. There is no opportunity to change the presentation of the subject into another geometry.
- A wide-area, uncollimated soil survey is a very different counting geometry than a waste drum.
- While a 2 L Marinelli beaker and large detector might be the best choice, you may have already standardized on 1 L beakers, so be sure any new detector will actually fit inside your existing Marinelli beakers.

How to Choose the Right Photon Detector for Your Application

Filter vs. Bottle vs. Marinelli Beaker

Remember the MDA (Eq. 1) depends on the absolute efficiency and the absolute efficiency depends on the geometry of sample and detector. You may select the sample geometry from several different containers. Lets look at some different samples counted on a single detector. In Fig. 7, the filter paper was placed directly on the endcap and the filter active area diameter is slightly smaller than the diameter of the detector. Would a smaller diameter detector or a larger diameter detector be better for this filter paper? The best detector diameter for a disk source on endcap (that is, in "close" geometry to the crystal) is about 1.2 times the diameter of the disk (Refs. 5, 6, and 7). A larger crystal does not increase the efficiency significantly and a smaller detector reduces the efficiency. The form of the sample also has an impact on the efficiency. Three different geometries are shown in Fig. 10 and you can see the filter geometry is, by far, the best of the three examples. So if you can, you should make disk samples rather than use the larger sample containers. The 1 L bottle is a larger diameter than the filter paper.

The situation changes if you want to determine specific activity or activity per unit sample, such as $\mu\text{Ci/kg}$. In such practical cases, you should consider, if it is possible to use the entire sample in that geometry. If only 1% of the sample could be put on the filter, but 100% of the sample could be put in the Marinelli beaker, then using the Marinelli beaker to count the whole sample would be more efficient over-all in terms of counts in the spectrum per unit activity in the original source.

In Fig. 11, 1 L and 2 L Marinelli beakers are compared on the same detector. It may seem at first surprising, but the 1 L beaker has a higher efficiency than the 2 L. The reason is back to simple geometry. The 1 L beaker puts a greater proportion of the sample closer to the detector. Thus 1000 Bq of activity in the 1 L beaker will produce more counts in the spectrum than 1000 Bq in the 2 L beaker. However, and it is important, if there is enough sample to fill the 2 L Marinelli, then the 2 L beaker will produce lower MDC (minimum detectable concentration MDA/volume) because of the larger sample.

Marinelli Beaker or a Bottle?

Figure 12 shows that a Marinelli beaker has about 3 times the efficiency of a bottle geometry. The Marinelli beaker utilizes the sides of the detector thereby gaining efficiency. At low energies, however the aluminum endcap wall, (replaced by beryllium or carbon fiber on the face of the GMX detector), will attenuate the gamma rays, thus reducing the advantage of the Marinelli.

What About "Wrap-Around" Geometries?

Figure 13 shows that a small disk on endcap has a higher efficiency than a sample wrapped around the curved surface of the detector. This initially surprising result can be explained as follows. Imagine a point source placed on the curved endcap surface. Directly below the source, the germanium is as close to the sample as if it is on the face of the endcap. However, when you consider gamma rays emitted at an angle, the curved surface puts the sensitive Ge further away from the source than it would be on the flat endcap face. However, as in the case of the 1 L

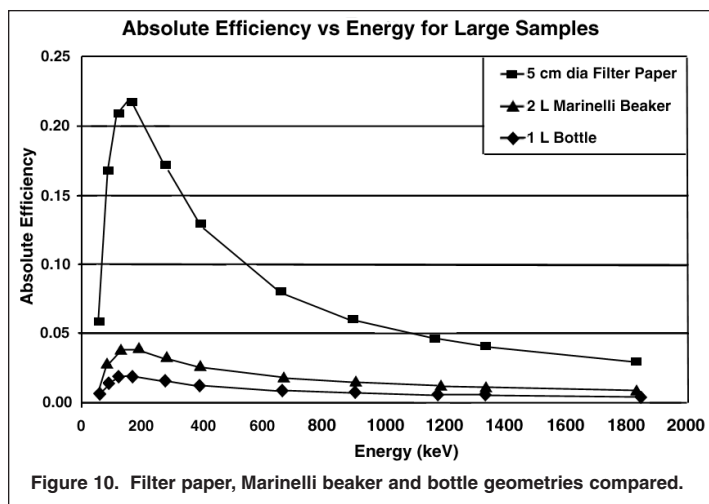

Figure 10. Filter paper, Marinelli beaker and bottle geometries compared.

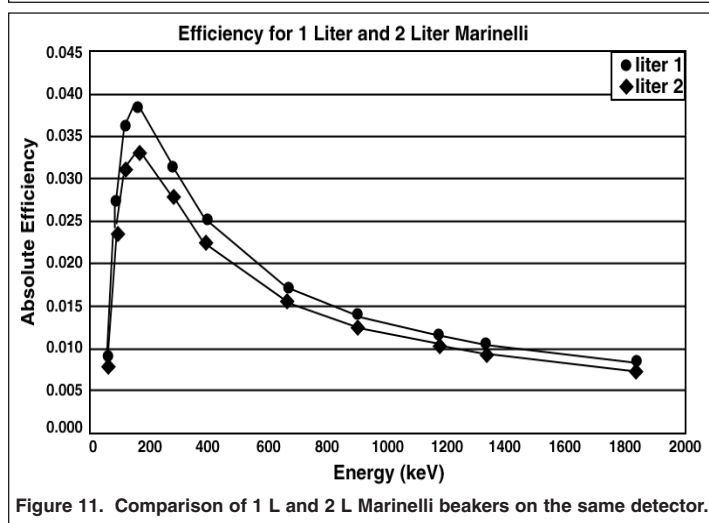

Figure 11. Comparison of 1 L and 2 L Marinelli beakers on the same detector.

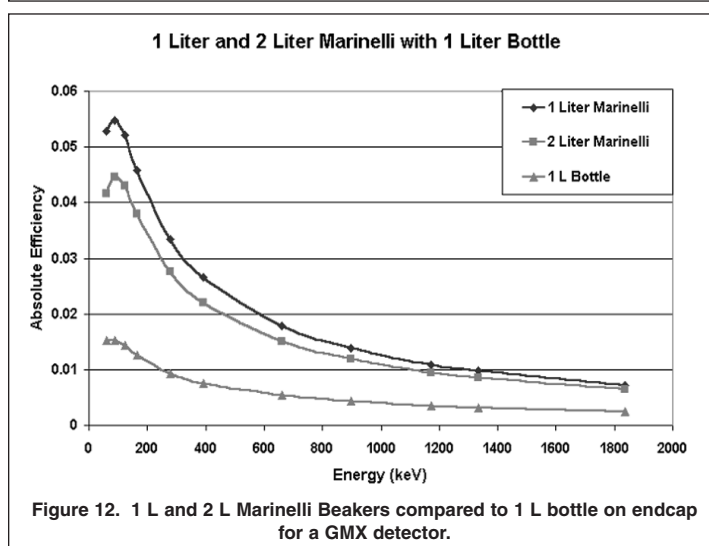

Figure 12. 1 L and 2 L Marinelli Beakers compared to 1 L bottle on endcap for a GMX detector.

How to Choose the Right Photon Detector for Your Application

and 2 L Marinellis in Fig. 12, if you can make the sample as large as the area of curved surface (much larger than the amount on the front flat surface), the curved surface has the highest efficiency in terms of counts in the spectrum per unit activity of the source. The cylindrical surface area in the detector in Fig. 10 was 15 times that of the flat disk on the end face of the crystal, which would more than offset the differences shown in the curves.

"Well" Detectors

The well detector (GWL Series) has been around for some years. A well detector has the highest geometric efficiency possible, but can only contain small samples and introduces some other complexities. The geometry is so "close" that coincident summing complicates calibration. Software can correct for coincident summing (TCC), but you must remember this if you are considering a well detector. Well detectors are for use in cases where the quantity of sample is very small, e.g., in some forensics applications.

GEOMETRY "Rules of Thumb"

- The closer the sample "activity center of gravity" is to the Ge, the higher the absolute efficiency, and the better the MDA
- The higher the absolute efficiency and the more sample counted, the better the MDA
- If all of the sample can be made into a small diameter disk on endcap, the only better geometry is a well detector
- For a disk on endcap, the crystal diameter should be at least 1.2 times the filter diameter for best efficiency

Making the correct choice not only means you get the best result, but can also save money. Look at the two detector efficiency plots shown in Fig. 14. comparing an 81% and 181% efficiency detector.

Because both detectors greatly exceed the diameter of the source, the sample-detector solid angle is large and there is no difference in efficiency at medium to low energies. At low energies, the thickness of the endcap and the dead layer make the 81% more efficient than the 181%. At medium energies, because the 81% detector is already quite long, the 181% detector has little advantage. At high energies, the larger detector will start to show real advantage (>1 MeV). Despite very similar performance in this geometry and over the energy range of 50 to 1000 keV, the purchase price of these two detectors will differ by a factor of two.

Count-Rate Considerations

In gamma spectrometry you want to obtain the best data possible. In high count-rate applications, you have many counts in the spectrum, but other issues become relevant in making the choice of detector and the system electronics.

What Count Rates are We Discussing?

- Low — Below 100 cps
- High — Above 75,000 cps input rate
- Very High — Above 100,000 cps

High and Very High Count Rates

A high-rate system must be operated at short shaping times to minimize the processing time per pulse. This will decrease the dead time and give maximum throughput. This shorter shaping time means the resolution is worse (peaks get wider) but not always significantly worse. Throughput is defined as the number of "useful" events stored in memory per second. Pulses which are too close together to be separated are called "pileup," and these can't be used because you don't know the separate energies of the pulses. The useful events (full energy peak area) is, of course, less than the total counts stored, but pileup events can't be used and even

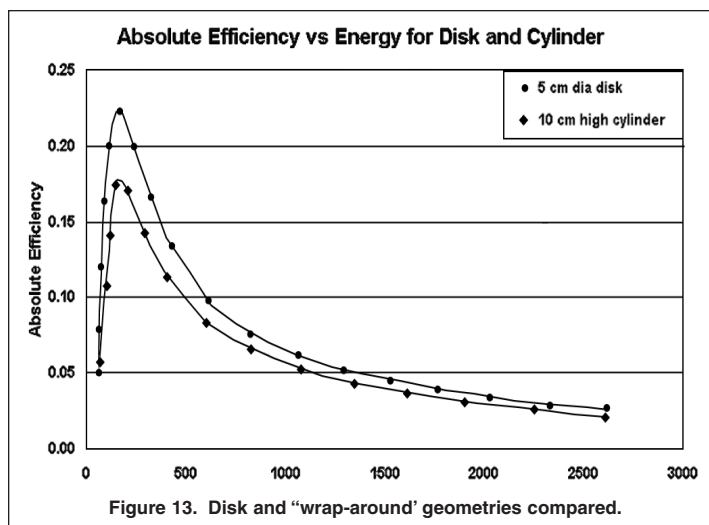

Figure 13. Disk and "wrap-around" geometries compared.

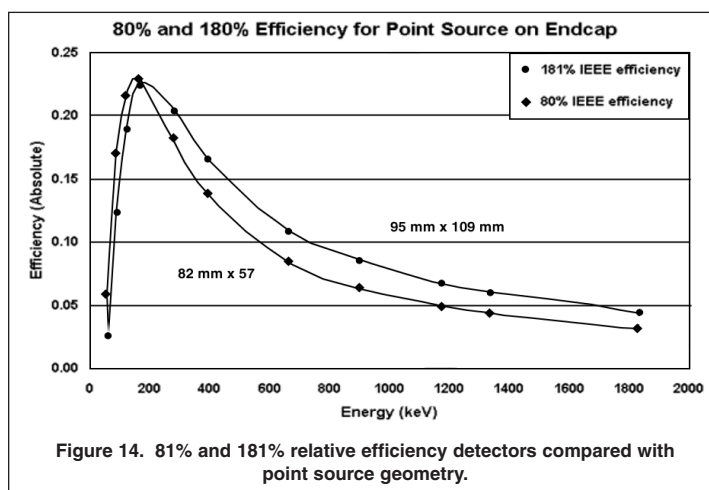

Figure 14. 81% and 181% relative efficiency detectors compared with point source geometry.

How to Choose the Right Photon Detector for Your Application

degrade signal to noise ratio in the spectrum. So when you consider high count rates, you must count just the good counts not all the counts.

The HPGc detector preamplifier will ultimately limit the system performance throughput and may affect the resolution. Resistor feedback preamplifiers have a limit on the amount of charge or power they can deliver and this is called the energy-rate product. The maximum energy-rate product is specified in MeV/sec (for example, 1000 CPS at 1 MeV = 1000 MeV/sec). At rates higher than this maximum rate, the preamplifier saturates, or freezes; no more pulses come out (Ref. 8).

Standard ORTEC GEM/GMX preamplifiers have an energy-rate limit of 145,000 MeV/sec while the LO-AX/GLP preamplifiers have a limit of 4000 MeV/sec. "Modified Resistor" GLP preamplifiers can be produced for special applications (e.g., safeguards) to a limit of 10,000 MeV/sec.

An alternative to the resistor feedback is the "Plus" or Transistor Reset Preamplifier (TRP). The TRP is effectively limitless, that is >1,000,000 MeV/sec.

It is important to realize that pulsed reset preamplifiers do not saturate and are therefore an excellent choice if wide ranges of count-rate may occur (e.g., accident monitoring), but the reset process increases dead time. Thus, a reset preamplifier will produce fewer counts to memory than a resistor feedback preamplifier operating below its point of saturation.

Throughput Limited Counting

Figure 15 shows a representative system throughput curve, (Ref. 9). The shape is typical of most throughput curves. Above the point of maximum throughput, pileup losses increase and, in terms of time taken to get to a given MDA, counting above the point of maximum throughput actually increases the counting time. This is because less and less data is being stored in memory as the input count rate increases. If you can change the input count rate by changing the counting geometry in some way, then the point of maximum throughput is the best place to operate. However in some cases, e.g., post accident monitoring, wide count rate variations "wide dynamic ranges" need to be accommodated.

The combination of the digital or analog shaping time chosen, the system processing dead time per pulse and the dead time due to the reset of the preamplifier (if not resistive), defines the system maximum throughput. Misleading claims are sometimes made in commercial literature about maximum achievable throughput of various electronic systems. However, the throughput limit is determined by the amplifier settings (or digital filter settings). These settings determine the dead time and resolution. So you select the settings based on the resolution you need, and this determines the throughput you can achieve.

Getting the Best Data When the System is Throughput-Limited

By choosing the correct detector, you can improve the quality of the spectral data. You might think that choosing a small detector would give superior high count-rate performance. This might be true for certain low-energy applications where very good resolution at very short shaping times is important (Ref. 9), but this is not always the case. Recall Fig. 4. In this figure, you see that the large detector has "higher peaks and lower valleys." Thus, for throughput-limited work at intermediate to high energies, a collimated larger detector will produce better quality data than a smaller detector, even though both may have the same capability in terms of throughput to memory. The larger detector has a higher proportion of photopeak (good) events in its pulse stream than Compton background (bad) events in comparison to the smaller detector.

Figure 16 shows two spectra superimposed taken with a 120% relative efficiency and a 12% relative efficiency P-type (GEM) detector (Ref. 8). The 120% GEM was collimated to produce the same over-all count rate as the 12% GEM. Peak net areas from the 120% are almost 3 times as large as those from the 12%

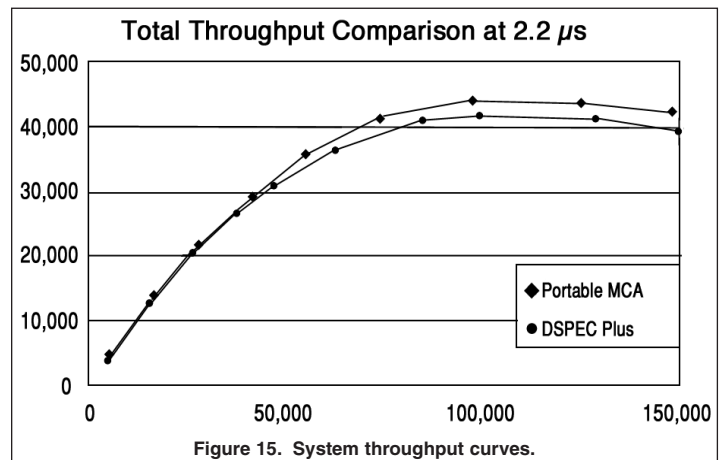

Figure 15. System throughput curves.

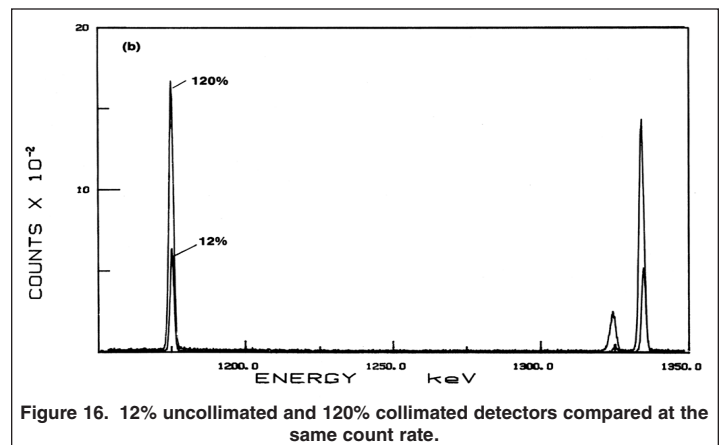

Figure 16. 12% uncollimated and 120% collimated detectors compared at the same count rate.

How to Choose the Right Photon Detector for Your Application

even though both are counting at the same count rate. Thus the 120% would have a "throughput limited MDA" almost 3 times better than that of the 12% for the same measurement time.

High Count-Rate "Rules of Thumb"

You will always have to make a trade-off between conflicting needs and performance.

- What is the "worst" tolerable resolution? This defines amplifier shaping time, and thereby throughput limits.
- Low energy only (planar)? Planar detectors can operate at short shaping times; special resistor option can trade resolution for throughput with no reset losses as in TRP.
- High energy? Consider using a collimated large coax to improve the data quality.
- Fixed high rate situation? Adjust the count rate to operate at the point of maximum throughput.
- TRP (Plus) or resistive? TRP for wide dynamic count rate ranges (no saturation), but some loss of throughput.

Low and Very Low Count Rates. Low Background Detectors.

Reduced and low background detectors are available, constructed with different degrees of low background specification. The background in the detector comes from natural emitters found in nearly all materials. By carefully selecting the materials used in the detector, these natural radionuclides can be significantly reduced. No detectors (low or otherwise) have non-mode radionuclides in the material. The background has both peaks and continuum. Ref. 11 describes the background and how to quantify it.

The Standard Options From ORTEC Are:

LB — Low Background

XLB — Low Background with lead backshield

RB — Reduced Background in PopTop

Low background (Ref. 7) options require specially selected materials, and therefore can add considerable cost to the detector. Before deciding that such a step is necessary, consider the following:

What problem are you trying to solve or mitigate? The basic principle should be removal of INTERFERENCE LINES which degrade the results. The background continuum is not usually the problem.

Examples:

In a lung burden system, the major source of background is the ^{40}K Compton background from the subject. If uranium is being measured, then some attention should be paid to removing sources of this line (including Compton-scattered events from the subject) from the spectrum.

In an In-situ measurement, the source of background is not the detector itself. You should first shield the detector from external radiation sources such as nearby containers.

Figure 17 shows the background in different detectors. If you are measuring uranium via the 186 keV line, then the reduced background PopTop or low background option rather than the standard detector is needed. This is due to uranium being present in the standard detector aluminum endcap.

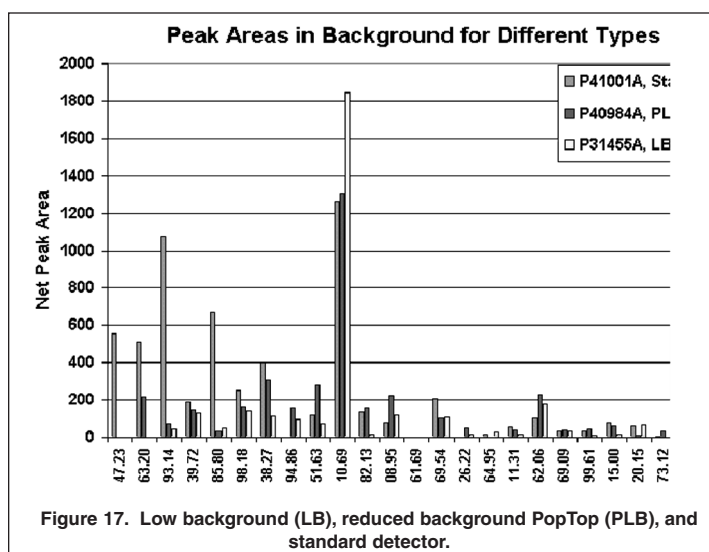

Figure 17. Low background (LB), reduced background PopTop (PLB), and standard detector.

How to Choose the Right Photon Detector for Your Application

The Cryostat

PopTop, the Versatile Cryostat Choice

ORTEC's proprietary transplantable PopTop capsule (U.S.A. Patent No. 4,851,684), attached to a companion cryostat and liquid nitrogen dewar, is the best solution for most applications. If you do choose PopTop, you will be able, inexpensively, to select more than one cryostat configuration, either now or later. If, for example, you decide on a vertical dipstick cryostat now, but decide later to use the detector both in the laboratory and in the field, you can obtain a Gamma Gage hand-held cryostat/dewar that will mate with the capsule. The capsule can be quickly attached to the Gamma Gage when going into the field, then re-attached to the vertical cryostat for use in the laboratory. PopTop LN₂ cooled detectors are field upgradeable to the X-COOLER II LN₂-Free cooling system.

Streamline (Non-PopTop) and Special Cryostats for Special Requirements

A streamline cryostat may be the best choice for certain demanding applications. For example, if ultra-low MDA is needed for particular lines that may be present in standard cryostats, the choice is an Extra-Low-Background (XLB) streamline cryostat, which has been optimized in every way for this purpose.

Streamline cryostats are routinely supplied for all low background, GWL, IGLET, and IGLET-X detectors.

For experiments in which the detector is to be subjected to intense fast neutron flux, a streamline cryostat is recommended.

ORTEC has produced many special cryostats designed to meet specific customer requirements. A noteworthy example is the array of 100 special detectors, of which 60 were "segmented," in GAMMASPHERE (Fig. 18), the largest such configuration of detectors in the world. Other specials include detectors used in balloon experiments, detector arrays flown in helicopters for gamma ray topology measurements, and internally-shielded detectors for Safeguards and post accident monitoring purposes.

Cryostat Materials

Are the lines to be quantified the same ones (or very close to those) that are often present in cryostat materials? (See Table 1.)

If the answer is **yes**, then a Low- or Extra-Low-background detector is needed to achieve detection limits. It can be provided in a wide choice of configurations.

If the answer is **no**, consider this next: **Will the count rates of the peaks to be quantified be comparable with the Compton background counts created by the radioactive isotopes that are present at low levels in a standard cryostat?*** If the answer to this question is **yes**, observe the spectra above (taken on two 55% efficiency detectors — one low-background, one standard). This is an example of the reduction in background count rate that can be achieved with a low-background cryostat.

The low-background cryostat is substantially better than the standard one for energies below ~500 keV, somewhat better between 500 and 1500 keV, and little better above that. If your peaks of interest are below 500 keV, you should invest next in a low-background cryostat. Between 500 and 1500 keV, the low-background cryostat may help to lower the MDA, but the same amount of investment in a higher-efficiency detector will produce about the same MDA improvement. (Obtaining both the low-background cryostat and the high-efficiency detector will produce the best possible results.) For measurements of lines at energies above 1500 keV, a low-background cryostat is of little value.

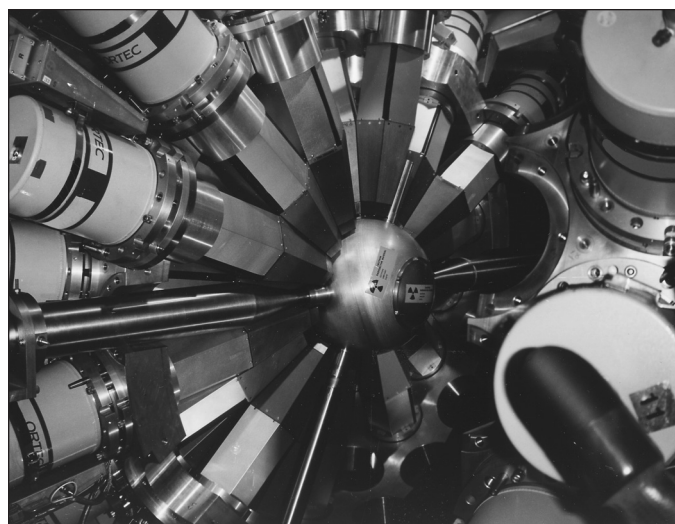

Fig. 18. View of GAMMASPHERE with Right Half Removed.

Table 1. Environmental Radionuclide Full-Energy Photopeak Energies.

Isotope (Parent Nuclide)	Energy in keV	Isotope (Parent Nuclide)	Energy in keV
U x-rays	13.0, 13.3*	¹³⁷ Cs	661.6
²³¹ U	25.6*	²¹⁴ Bi (²³⁸ U)	727.2
¹³⁷ Cs	31.8, 32.2, 36.4*	^{234m} Pa (²³⁸ U)	766.6
²¹⁰ Pb (²³⁸ U)	46.5	²²⁸ Ac (²³² Th)	911.0
²³⁴ Th (²³⁸ U)	63.3	²²⁸ Ac (²³² Th)	969.0
²³⁴ Th (²³⁸ U)	92.6	^{234m} Pa (²³⁸ U)	1001.0
²³⁵ U, ²²⁶ Ra	185.7, 186.2	²¹⁴ Bi (²³⁸ U)	1120.3
²¹² Pb (²³² Th)	238.6	⁶⁰ Co	1173.0
²¹⁴ Pb (²³⁸ U)	295.2	²¹⁴ Bi (²³⁸ U)	1238.0
²¹⁴ Pb (²³⁸ U)	351.9	⁶⁰ Co	1332.5
Cosmic	511.0	⁴⁰ K	1460.8
²⁰⁸ Tl (²³² Tl)	583.1	²¹⁴ Bi (²³⁸ U)	1764.5
²¹⁴ Bi (²³⁸ U)	609.3	²⁰⁸ Tl (²³² Tl)	2614.5

* The lines lower than 46 keV are reported only for LO-AX and GMX detectors.

How to Choose the Right Photon Detector for Your Application

Cryostat Choice for Ultra-Low-Level Measurements

There are two popular cryostat configurations often chosen for ultra-low MDA. They are (a) the J configuration, which makes it possible to shield the dewar, much of the cryostat, and the cryosorption material from the detector element, and (b) the HJ configuration, which, in addition, allows the preamplifier to be shielded from the detector element. These are available in streamline cryostats.

Shielding

Applications that have count rates sufficiently high that the total of background counts from all sources is insignificant need neither special shielding nor a low-background detector. However, if high sample throughput and low MDA must be obtained for low-level samples, the contribution from background radiation (the outside world and the cryostat) is of definite concern.

A good quality, low-background lead shield (containing ~4 inches of low-radiogenic lead) that will accommodate the detector is essential.

References

1. G.Gilmore and J.D. Hemmingway, "Practical Gamma-Ray Spectrometry," Wiley 1995 ISBN 0 471 95150 1.
2. J.A.Cooper, "Factors Determining the Ultimate Sensitivity of Ge(Li) Gamma-Ray Spectrometers", Nucl Instr and Meth 82 (1970) 273-277.
3. R.Keyser, T. Twomey, and S. Wagner, "Benefits of using Super-Large Germanium Gamma-Ray Detectors for the Quantitative Determination of Environmental Radionuclides," Radioactivity and Radiochemistry, Vol 1 No 2 , pp 46-56 (Spring 1990).
4. "IEEE Test Procedures for Germanium Detectors for Ionizing Radiation," ANSI/IEEE Standard 325-1986
5. R.M. Keyser, T.R Twomey, P. Sangsingkeow, "Advances in HPGe Detectors for Real-World Applications," ORTEC 1999.
6. R.M. Keyser, T.R Twomey, and P. Sangsingkeow, "Matching Ge Detector Element Geometry to Sample Size and Shape: one does not fit all!," Proceedings of the 1998 Winter Meeting of the ANS, Nov 1998.
7. ORTEC Charged Particle and Photon Detector Catalog CD-ROM available from www.ortec-online.com
8. T.R Twomey, R.M. Keyser, M. L. Simpson, and S.E Wagner, ORTEC, "High Count Rate Spectroscopy with Ge Detectors : Quantitative Evaluation of the Performance of High Rate systems," Radioactivity and Radiochemistry, Vol 2 , No 3 (1991).
9. R.D. Bingham, R.M. Keyser, T.R. Twomey, "An Innovative, Portable MCA Based on Digital Signal Processing," Conference Proceedings, 23rd ESARDA meeting on Safeguards and Nuclear Materials Management, Brugge, May 2001
10. See, for example: R. Keyser, T. Twomey, S. Haywood, W. E. Parker, T.F. Wang, D. Clark, K. Raschke, W.Romine, W. Buckley and W. Ruhter, "Recent Developments in the MGA++ Codes," ESARDA Conference, Seville, Spain, May 1999.
11. "Test Methods for Spectrum Background Determination in HPGe Spectrometry," IEC 61976-2000.

How to Choose the Right Photon Detector for Your Application

Photon Detector Applications Summary Guide

Application	Most Suitable Detector(s)
Synchrotron light studies; Soft x-ray (fusion) research	IGLET, IGLET-X, SLP, GLP
PIXE	SLP, IGLET, IGLET-X
Large environmental samples with complex spectra	GEM, GEM-F, GEM-M, GEM-MX, GMX, (low-background recommended)
Environmental samples on filter media, dishes or bottles	GEM-F, GEM-FX, GEM-MX, GEM, GMX
Small environmental samples	GWL (low-background recommended)
High-grade fissile materials	SGD, SGD-GEM
Neutron activation analysis	GMX (PLUS option recommended)
Post-accident monitoring	GEM (PLUS option recommended)
Compton-suppressed gamma spectroscopy	GMX, GEM (based on range of energy interest)
Sea or airborne surveillance	Micro-trans-SPEC, trans-SPEC-DX-100T, IDM
Lung monitoring	Actinide-85
Measurements in-beam or near fast-neutron fields	GMX (special internal heater for in-situ neutron damage anneal recommended)
Waste assay	Micro-trans-SPEC, trans-SPEC-DX-100T, GEM, GMX
Freight/Border Security	Micro-Detective, Detective-EX, Detective-DX, IDM
In-Situ environmental spectroscopy	Micro-trans-SPEC, trans-SPEC-DX-100T, GEM, GMX

How to Choose the Right Photon Detector for Your Application

Photon Detector Selection Guide										
Type of ORTEC Detector	Geometry	Window Thickness (µm)	Useful Energy Range	Material	Standard* Sizes	Standard* Energy Resolutions	Standard* Peak to Compton	Standard Peak Shapes		Warranted Temperature Cyclable
								FW.1M/FWHM	FW.02M/FWHM	
GEM	Closed-End Coaxial	700	40 keV–10 MeV	P-type HPGe	10%–150% Efficiency	175–240 keV @ 1.33 MeV	37:1–90:1	1.90–2.00	2.65–3.10	Yes
PROFILE GEM	Closed-End Coaxial	700	40 keV–10 MeV	P-type HPGe	59–90 mm Diameter 20%–175% Nominal Eff.	675–1300 eV @ 122 keV 1.85–2.3 keV @ 1.33 MeV	40:1–90:1	1.90–2.00	2.65–3.10	Yes
PROFILE GEM-FX	Closed-End Coaxial	<15 (face) 700 (sides)	10 keV–3 MeV	P-type HPGe	58–85 mm Diameter 35%–55% Nominal Eff.	485–600 eV @ 14.4 keV 650–700 eV @ 122 keV 1.8–1.9 keV @ 1.33 MeV	35:1–55:1			Yes
PROFILE GEM-MX	Closed-End Coaxial	<15 (face) 700 (sides)	10 keV–10 MeV	P-type HPGe	59–94 mm Diameter 38%–175% Nominal Eff.	800–1280 eV @ 14.4 keV 900–1300 eV @ 122 keV 1.8–2.3 keV @ 1.33 MeV	62:1–90:1			Yes
GMX	Thin Window Coaxial	0.3 Ion Implanted	3 keV–10 MeV	N-type HPGe	10%–100% Efficiency	1.90–2.65 keV @ 1.33 MeV	38:1–64:1	1.90–2.30	2.65–3.30	Yes
GWL	Well	0.3 Ion Implanted	10 keV–10 MeV	P-type HPGe	Up to 400 cc Active Volume	2.10–2.30 keV @ 1.33 MeV 1.20–1.40 keV @ 122 keV				Yes
GLP	Planar	0.3 Ion Implanted	3 keV–300 keV	P-type HPGe	6–36 mm Diameter	165–385 eV @ 5.9 keV 480–595 eV @ 122 keV				Yes
LO-AX	Short Thin-Window Coaxial	0.3 Ion Implanted	3 keV–1 MeV	N-type HPGe	36–70 mm Diameter	300–495 eV @ 5.9 keV 585–720 eV @ 122 keV				Yes
SLP	Planar	0.1	1 keV–30 keV	Lithium Drifted Silicon	4–16 mm Diameter	160–250 eV @ 5.9 keV				Yes
IGLET	Special	0.1	3 keV–>60 keV	P-type HPGe	6–16 mm Diameter	135–160 eV @ 5.9 keV				Yes
IGLET-X	Special	<0.1	<1 keV–>60 keV	P-type HPGe	6–16 mm Diameter	135–160 eV @ 5.9 keV				Yes

*Detectors of different size, resolution, peak/Compton ratio, and peak shape are available on special order.

Specifications subject to change
031811

ORTEC[®]

www.ortec-online.com

Tel. (865) 482-4411 • Fax (865) 483-0396 • ortec.info@ametek.com
801 South Illinois Ave., Oak Ridge, TN 37831-0895 U.S.A.
For International Office Locations, Visit Our Website

AMETEK[®]
ADVANCED MEASUREMENT
TECHNOLOGY