



**MVS-7000 Series
MACHINE VISION STROBE**

OPERATION MANUAL

*Excelitas Technologies Illumination, Inc
35 Congress St., Salem, MA 01970 USA
Phone: (978)745-3200 FAX: (978)745-0894
Toll Free: (800)950-3441 in USA only
Website <http://www.excelitas.com>*

**WARNING!**

The MVS-7000 produces lethal voltages. Ensure that input power is disconnected and storage capacitors have been discharged before beginning any inspection or internal adjustment.

WARNUNG!

Das MVS-7000 erzeugt lebensgefährliche Spannungen. Es muss deshalb darauf geachtet werden, dass der ankommende Strom ausgeschaltet ist und die Ladekondensatoren entladen sind, bevor Kontrollen oder Regelungen am Gerät unternommen werden!

ATTENTION!

Le MVS-7000 fournit des tensions dangereuses. Veuillez vérifier que la prise de courant est déconnectée et les condensateurs d'accumulation sont déchargés avant d'entreprendre des inspections ou des réglages sur l'appareil.

**WARNING!**

The output voltage of the MVS-7000 **MUST** be limited to match the specifications of those components to which it is connected. Exposing any system component to voltage (or any other operating condition) that exceeds its rating can result in damage to the unit and personal injury.

**WARNUNG!**

Die Ausgangsspannung des MVS-7000 muss der Leistung aller damit verbundenen Komponenten angepasst werden. Systemelemente Spannungen (oder anderen Betriebsbedingungen) auszusetzen, die die Leistungswerte jener Komponenten übertreffen, ist gefährlich und kann zu Schäden und Verletzungen führen.

ATTENTION!

Il faut que la tension fournie par le MVS-7000 soit limitée aux caractéristiques des composants auxquels il sera mis en contact. En exposant un composant quelconque à une tension (ou à d'autres conditions de fonctionnement), qui en dépasse la limite on pourrait endommager l'appareil ou provoquer des blessures.

**WARNING!**

Do not exceed the specified rates for voltage and flashrate. Do not operate at more than 43 watts of average output power.

WARNUNG!

Bitte, die vorgegebenen Grenzwerte bei der Spannung und Blitzfrequenz nicht überertreffen. Leistungen höher als 43 Watt sind nicht zulässig.

ATTENTION!

Eviter de dépasser les valeurs limites inscrites pour la tension et la fréquence d'éclat. Eviter aussi des puissances au dessus de 43 Watt.

TABLE OF CONTENTS

	<u>page</u>
1.0 INTRODUCTION _____	2
1.1 Description _____	2
1.2 Unpacking _____	2
2.0 SPECIFICATION TABLES _____	4
3.0 INSTALLATION _____	5
3.1 Mounting _____	5
3.2 Safety Requirements _____	5
4.0 OPERATION _____	6
4.1 Output Connections _____	6
4.2 Input Connections & Intensity Control Switch _____	7
4.3 Intensity Adjustment (Internal Mode) _____	8
4.4 Intensity Adjustment (External Mode) _____	9
4.5 Voltage Setting Versus Lamp Life _____	9
5.0 MAINTENANCE _____	10
5.1 Repairs _____	10
5.2 Flashlamp Module Replacement _____	11
5.3 Cleaning _____	12
5.4 Repacking And Storage _____	12
6.0 DECLARATION OF CONFORMITY _____	13

FIGURES

FIGURE 1 – Outline and Mounting Dimensions _____	3
FIGURE 2 - Signal Input Connector (J2) _____	7
FIGURE 3 - Input Trigger Circuit _____	7
FIGURE 4 - Simplified Schematic _____	12

TABLES

TABLE 1 - Optical _____	4
TABLE 2 - Electrical _____	4
TABLE 3 - Environmental _____	4
TABLE 4 - Nosepieces _____	6
TABLE 5 - Fiber Optic Bundles _____	6
TABLE 6 - Signal Input Connector - J2 _____	8

1.0 INTRODUCTION

1.1 Description

Machine Vision Strobes (hereafter referred to as the "7000 Series") are sources of short duration, high intensity light pulses for industrial vision applications. The units come complete with an input power cable and a connector for a control input cable. The light source is a Excelitas Technologies high power xenon flashlamp. The light output is focused on a port configured to accept a fiber-optic cable (optional; see Table 4) so that light can be transmitted to an area remote from the instrument.

The 7000 Series can be used for a wide variety of industrial robotics production applications, including: sorting, package integrity verification, counting, label reading, component orientation, motion sensing, edge detection, contaminant detection, part recognition, color differentiation and quality assurance.

For operation, the 7000 Series unit requires a TTL input pulse from the camera system to initiate a flash, and connection to a 90-230V AC, 50/60Hz line, single phase with ground.

Please read and follow all safety precautions, such as:

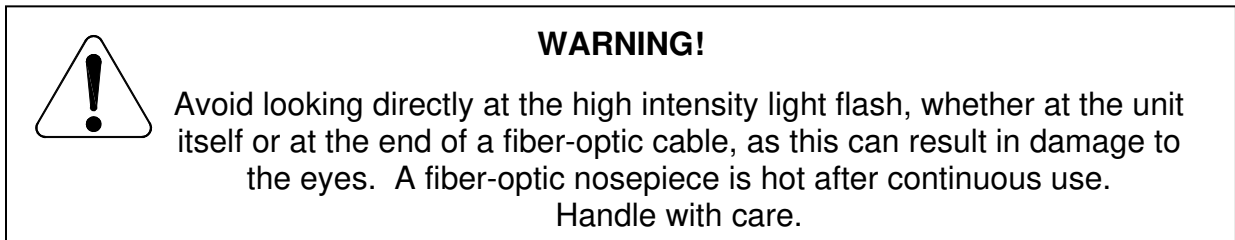
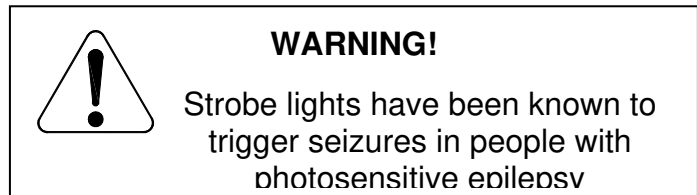
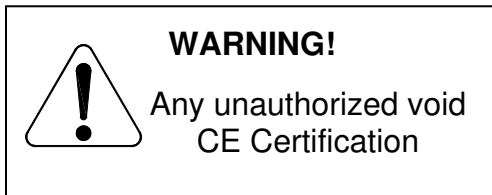

1.2 Unpacking

If the condition of the outer packaging suggest mishandling has occurred, examine the 7000 Series strobe for any signs of breakage during shipment. The Xenon Flashlamp is particularly vulnerable to rough treatment during shipment. Although the utmost care is taken to preserve the integrity of this item, its fragile nature makes it susceptible to breakage if the container is mishandled in transit. If there are any obvious signs of damage, contact the carrier immediately and do not proceed with the installation. It is recommended that the packaging material be retained and stored in the event that the unit has to be reshipped.

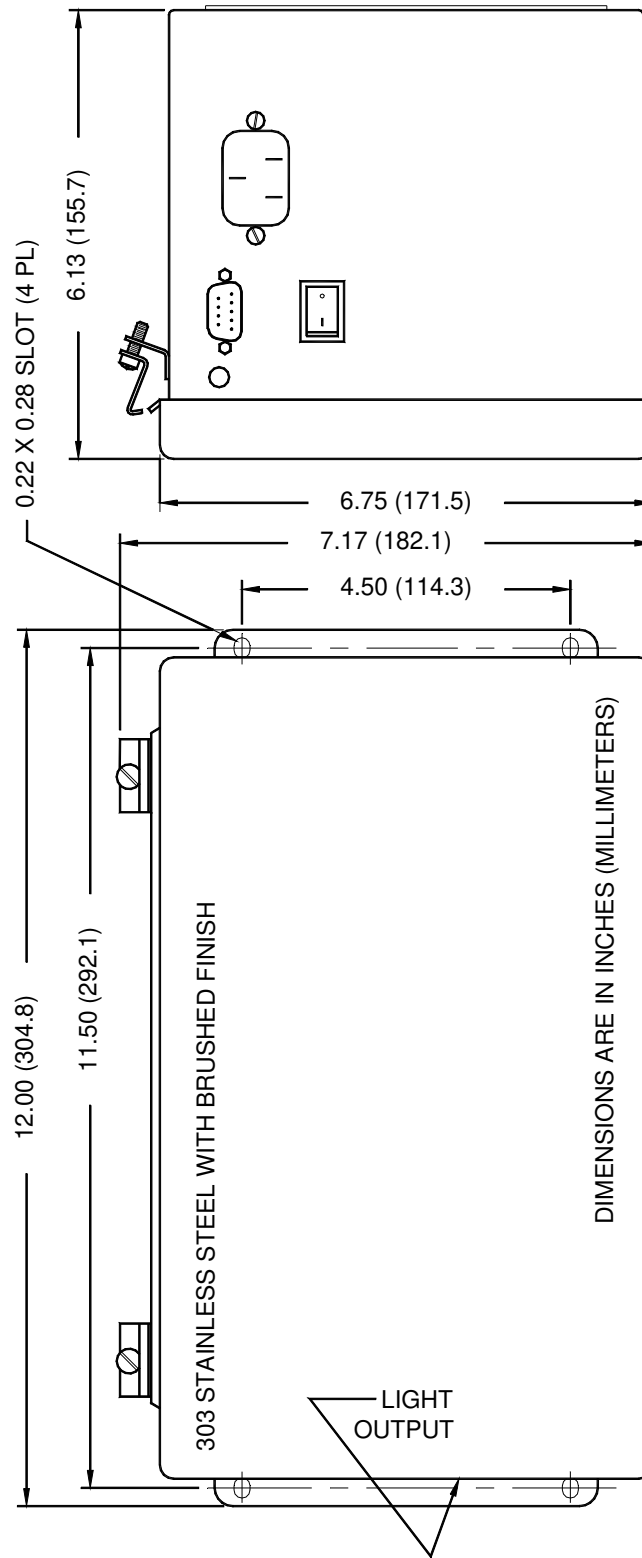

FIGURE 1 – Outline and Mounting Dimensions

2.0 SPECIFICATION TABLES

TABLE 1 - Optical	<i>MVS-7010</i>	<i>MVS-7020</i>	<i>MVS-7060</i>
Spectral bandwidth	225-1100+nm	225-1100+nm	225-1100+nm
Radiometric light output**	210mJ	120mJ	50mJ
Flash rate in Hz @ 600V*	10 max.	20 max.	60 max.
Pulse duration @ 1/3 peak	30 μsec	15 μsec	10 μsec
Fiber bundle outside diameter	1.0 inch (25mm) max.		

*Flash rate is voltage dependent. Do not exceed 43W average power. [Power=Energy x frequency (**P=Ef**) and Energy=1/2 Capacitance x Voltage² (**E=1/2CV²**)]

**Approximate light output measured through a 1/2" aperture at the light output port (@600VDC).

TABLE 2 - Electrical	<i>MVS-7010</i>	<i>MVS-7020</i>	<i>MVS-7060</i>
Input voltage	90-230VAC ±10%, 50/60Hz		
Input Power	60 Watts		
Trigger input	+5V, 20mA, 10-100μsec pulse (into an opto-isolator with internal 150 ohms nominal series resistor)		
Flashlamp voltage (factory set)	600VDC	600VDC	600VDC
Discharge capacitor	24μF	12μF	4μF
Input energy per flash @ 600V*	4.32 joules	2.16 joules	0.72 joules
Delay between flash command and light output	10μsec (typ)	10μsec (typ)	10μsec (typ)
Ext ref. voltage	5 to 10 volts DC ($V_0 = V_{ref} \times 60$)		

*Flash rate is voltage dependent. Do not exceed 43W average power. Power=Energy x frequency (**P=Ef**) and Energy=1/2 Capacitance x Voltage² (**E=1/2CV²**)]

TABLE 3 - Environmental

Operating temperature	-10 to +104 F (-23 to +40 C)
Storage temperature	-40 to +194 F (-40 to +90 C)
Humidity	0% to 85% Non-Condensing



WARNING!



Because this product is only one component of a system, and, once sold is exclusively under the control of the user, it has the potential of being used in a manner outside the intended purpose of Excelitas Technologies Illumination, Inc. design.

It is essential that the operating specifications and parameters described in Excelitas Technologies literature and those accompanying other manufacturer's components be observed and not be exceeded under any conditions.

To install or operate this product in a manner for which it is not intended may cause personal injury or **death**, as well as severe damage to the product and/or other system components.

3.0 INSTALLATION

3.1 Mounting

Four holes in the base of the 7000 Series enclosure are available for mounting the unit (see Figure 1). Mounting hardware is user-supplied. Position the unit so that the AC receptacle is accessible as a means of disconnect.

3.2 Safety Requirements

The MVS-7000 has features related to safety, such as:



To prevent the possibility of injury from *flashlamp breakage*, leave either the **plastic lamp cap** or a **fiber-optic cable** in place at all times. *Do not operate the unit with the lamp cap in place.* See flashlamp replacement warning on page 11.

Use the **AC Receptacle** (on the right) as a disconnect device to remove any possibility of electrical input, particularly, when accessing the unit's interior.

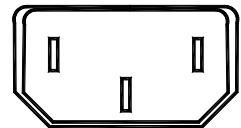

4.0 OPERATION

4.1 Output Connections

Use a nosepiece (Table 4) or a nosepiece with adapter to connect a fiber-optic cable (Table 5) to the unit's light output port.* Position the cable to distribute light to the desired area.

TABLE 4 - Nosepieces

TYPE	DESCRIPTION
MVS-22	Fostec Special 1" dia. Nosepiece
MVS-23	Fostec Standard 0.72" dia. Nosepiece
MVS-24	Volpi Standard 0.59" dia. Nosepiece
MVS-25	Dolan Jenner Standard 1.0" dia. Nosepiece (used with 1.0" O.D. Adapter)

TABLE 5 - Fiber Optic Bundles

(by Excelitas Technologies Illumination, Inc.)¹

TYPE	DESCRIPTION
MVS-7 Single	Illuminates a small area from one direction; 40 in. (102cm) long.
MVS-7D Dual	Reduces shadows by illuminating from two directions; 40 in. (102cm) long.
MVS-8 Ring Light	Illuminates an area of 2 in. with working distance of 4 in.; dependent on distance from light source and illumination plane; 36.5 in. (93cm) long.
MVS-12 Backlight ²	2x2 in. area; uniformity is $\pm 5\%$ over usable working area; 37 in. (94cm) long.
MVS-13 Backlight ²	4x5 in. area; uniformity is $\pm 5\%$ over usable working area; 37 in. (94cm) long.

¹See Excelitas Technologies Illumination, Inc. Data Sheet, [Machine Vision Strobe, Fiber Optic Bundles](#).

²Caution: High intensity may damage *PLASTIC* fiber optic bundles. Contact manufacturer for temperature limits and use IR filter to reduce heat.

*Note: Be sure to remove the safety cover from the output port before operating the unit.

4.2 Input Connections & Intensity Control Switch

Two input connections are provided at one end of the enclosure. The larger connector is used to attach the input power cable (supplied).

The smaller, 9-pin connector (see Figure 2) is used to attach a cable for trigger and reference voltage inputs. A mating connector is supplied. Use a shielded cable, 90% coverage or better, 360 terminated to the back of the shell. To trigger the strobe, a +5V TTL pulse (10-100 usec, >20 mA) is required to activate the opto-isolator. The strobe will flash on the rising edge of the positive pulse. Do not exceed 6V since this will result in permanent damage to the strobe. Other logic voltages can be accommodated by the addition of a series resistor (Please Contact Factory). A Trigger Test Module (MVS-103) at a fixed flash rate (6 Hz) is available through Excelitas Technologies to test your MVS-7000 Series strobe. This small module (1½" x 1" x 2½") plugs directly into the D-connector and can be used to verify correct operation of the MVS-7000 Series strobe unit.

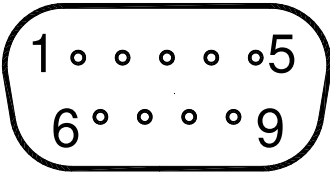

FIGURE 2 - Signal Input Connector (J2)

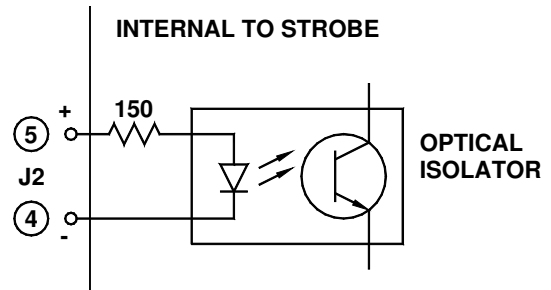

FIGURE 3 - Input Trigger Circuit

The intensity of the MVS-7000 Series strobe can be adjusted by means of a potentiometer (INTERNAL mode, see section 4.3) or an external reference signal (EXTERNAL mode, see section 4.4). A slide switch S1, located on the main power supply PC board, allows the user to switch from INTERNAL to EXTERNAL mode for intensity adjustment. (Units are shipped with the switch S1 in the INTERNAL position).

Note: With the switch S1 in the EXT. position, an external reference voltage (5-10 VDC) on Pin 3 and Pin 9 is required to operate the strobe. Without this reference signal, the strobe will NOT flash (see section 4.4).

TABLE 6 - Signal Input Connector - J2

	INTERNAL V_{ref} SETTING (S1-INT)	EXTERNAL V_{ref} CONTROL (S1-EXT)
Pin 1	No connection	No connection
Pin 2 ¹	No connection	No connection
Pin 3 ¹	No connection	V_{ref} : reference signal input voltage, 5-10VDC ($V_0 = V_{ref} \times 60$)
Pin 4	- Trigger: opto-isolator trigger return	- Trigger: opto-isolator trigger return
Pin 5	+Trigger: opto-isolator trigger input; 5v, 20mA; triggers on rising edge.	+Trigger: opto-isolator trigger input; +5v, 20mA; triggers on rising edge.
Pin 6	No connection	No connection
Pin 7	No connection	No connection
Pin 8	Chassis ground	Chassis ground
Pin 9	No connection	V_{ref} return, supply ground

¹If External V_{ref} is not used, set slide switch to INT and leave internal ref. at factory setting (600VDC).

4.3 Intensity Adjustment (Internal Mode)

With the slide switch S1, located on the main power supply PC board, in the INT position, the user can change the intensity of the strobe by adjusting a potentiometer without opening the strobe enclosure. This potentiometer is labeled 'Internal VREF Adjust' and is located on the back of the unit just above the signal input connector next to the ON/OFF switch.

By adjusting the 10-turn pot (or 1 turn pot on any of the MVS-7000-03 models), using a small screwdriver, the user can vary the voltage on the main discharge capacitors from 300 VDC to 600 VDC. The intensity or energy per flash will vary as $\frac{1}{2}$ capacitance x (voltage)² (or $E = \frac{1}{2}CV^2$). The voltage has been factory set at 600 VDC. For reliable flashing over the life of the lamp, it is not recommended to operate the strobe at less than 400 VDC.

The actual output voltage setting (300-600 VDC) can be measured by monitoring the internal V_{ref} setting (5-10 VDC) through the signal input connector J2. By disengaging the 9 pin D-connector, the user can measure the DC voltage between Pin 3 and Pin 9. The output voltage is 60 times the reference signal ($V_{out} = V_{ref} \times 60$).

4.4 Intensity Adjustment (External Mode)

To change the intensity adjustment from the factory setting (INTERNAL mode) to an external reference signal (EXTERNAL mode), the user must slide switch S1, located on the main power supply PC board, to the EXT position. This requires opening the enclosure to access the interior of the enclosure.

Please read and follow all safety precautions!

1. Switch off the unit and allow it to cool.
2. Disconnect the AC cord from the unit.
3. Wait at least 60 seconds to allow the energy storage capacitors to discharge.
4. Using a screwdriver, loosen the screws on the clamps holding the cover and open the case.
5. Ground discharge capacitors with an insulated shorting bar to insure the stored energy is discharged.
6. Slide switch S1 (at lower left corner of unit and top edge of PC board) to the EXT position.*
7. Close the cover and secure the clamps before reconnecting the AC cord.

* To restore the internal voltage adjust, repeat the above procedure and slide the switch to the INT position.

Note: With the switch S1 in the EXT position, an external reference voltage is required to operate the strobe. Without this reference signal the strobe will NOT flash.

An external reference signal can be used to control the intensity of the strobe. A

5-10 VDC reference signal should be connected to pin 3 (Vref) and pin 9 (Vref return). The actual voltage on the storage capacitors is 60 times the reference signal ($V_{out} = V_{ref} \times 60$). The output voltage can be varied from 300 VDC to 600 VDC. The intensity or energy per flash will vary as $\frac{1}{2}$ capacitance \times (voltage)² (or $E = \frac{1}{2}CV^2$). For reliable flashing over the life of the lamp, it is not recommended to operate the strobe at less than 400 VDC.

4.5 Voltage Setting Versus Lamp Life

Lamp life is dependent on the energy per flash. For maximum lamp life lower the lamp voltage to a minimum, that will allow sufficient light output for your application. However, for reliable flashing over the life of the lamp, it is not recommended to operate the strobe at less than 400 VDC.

5.0 MAINTENANCE



WARNING!

The MVS-7000 Series strobe produces lethal voltages. Ensure that input power is disconnected and storage capacitors have been discharged before beginning any inspection or cleaning.

5.1 Repairs

The 7000 Series strobe is, generally speaking, a trouble-free unit. No routine maintenance or repair is suggested, except for replacement of the flashlamp module.

The unit is protected by a 3.15A fuse (Type T), in the AC input. If the fuse opens, do not replace it. Return the unit to the factory for repair.

In the event that the unit fails or does not function properly (other than flashlamp failure), it is strongly suggested that no attempt be made to troubleshoot. Field repairs and customer modifications are not authorized, and, if attempted, will void the warranty. Repairs must be made only by factory-trained personnel.

5.2 Flashlamp Module Replacement



WARNING!

The flashlamp is a high-pressure, gas-filled device. Wear safety glasses when replacing it. Avoid touching it with bare hands as fingerprints will burn into the glass and effect the life of the lamp.



Over a period of time (depending on usage), the xenon flashlamp may deteriorate and have to be replaced. To replace the module (P/N XP-0861):

REMOVAL:

1. Remove line voltage from the unit.
2. Wait 60 seconds to allow energy storage capacitors to discharge.
3. Ground discharge capacitors with an insulated shorting bar to insure stored energy is discharged.
4. Disconnect faston connectors from the lamp module terminals.
5. Loosen the two screws at the front of the lamp module. Remove the screws at the rear of the lamp module. Slide the lamp module forward slightly so that the screw heads are in the larger part of the slots and lift.

INSTALLATION:

1. Make sure that the line voltage is disconnected from the unit.
2. Hand tighten the hexagonal standoffs in the bottom of the enclosure.
3. Insert the lamp module into the enclosure and slide it backwards slightly so that the two screws at the front of the lamp module are in the small part of the slots.
4. Insert and tighten the two screws at the rear of the lamp module. Then tighten the screws that secure the front of the lamp module.
5. Connect the white lead to the faston terminal on the lamp heatsink and connect the black lead to the faston terminal on the back plate of the lamp module.

5.3 Cleaning

After disconnecting power from the unit, clean with a soft cloth dampened with a mild, non-abrasive cleaner and wipe dry. *Never immerse the unit in water or any other liquid.*

5.4 Repacking And Storage

If the 7000 Series strobe is to be stored for a prolonged period, shipped to another location, or returned to the factory for repair, it should be repacked in the original packaging material. If this material has been discarded, the unit should be repacked so as to prevent movement within the container and damage from improper handling

A storage area should be dry, at a temperature of -40 F to +194 F (-40 C to +90 C).

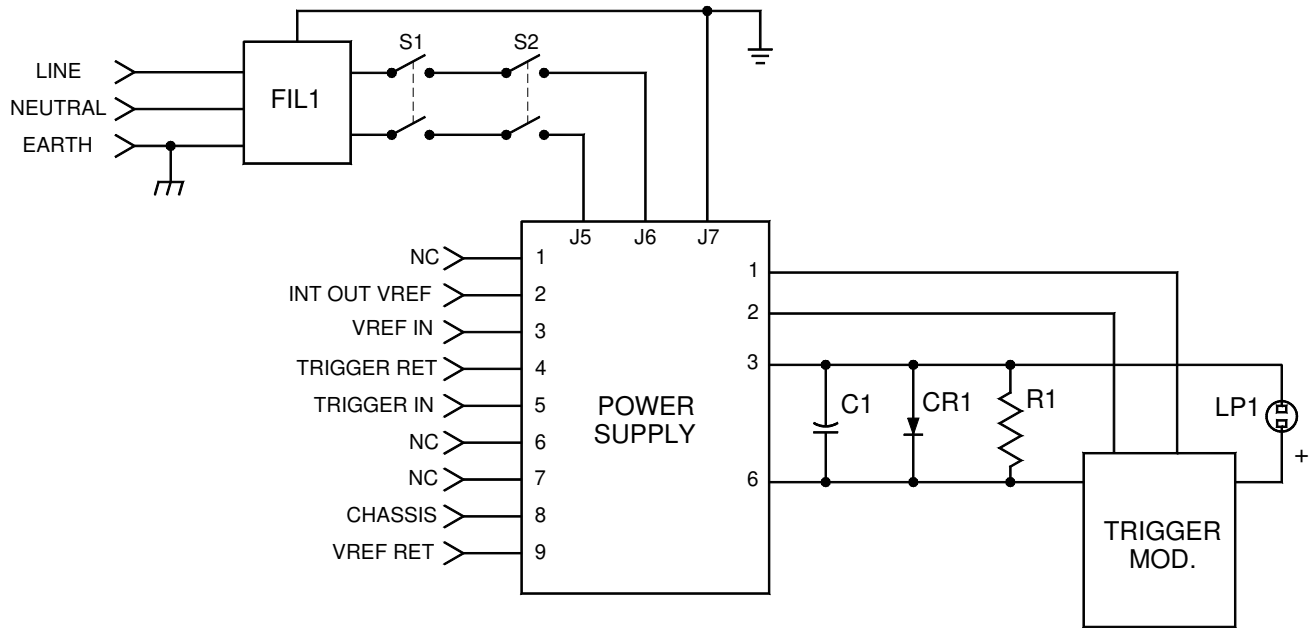

FIGURE 4 - Simplified Schematic

6.0 DECLARATION OF CONFORMITY

MANUFACTURER:

Excelitas Technologies Illumination, Inc.
35 Congress Street
Salem, Massachusetts 01970 U.S.A.

EUROPEAN REPRESENTATIVE

Excelitas Technologies GmbH:
Wenzel-Jaksch-Str. 31
D-65199 Wiesbaden Germany

Part Number	Model Number	Product Description
302-7010	MVS-7010	Machine Vision Strobe (10Hz, 24uF, 600V)
302-7010-03	MVS-7010-03	
302-7010-04	MVS-7010-04	
302-7013	MVS-7013	
302-7020	MVS-7020	Machine Vision Strobe (20Hz, 12uF, 600V)
302-7020-03	MVS-7020-03	
302-7020-04	MVS-7020-04	
302-7023	MVS-7023	
302-7030	MVS-7030	Machine Vision Strobe (30Hz, 8uF, 600V)
302-7060	MVS-7060	Machine Vision Strobe (60Hz, 4uF, 600V)
302-7060-03	MVS-7060-03	
302-7060-04	MVS-7060-04	

We, Excelitas Technologies Illumination, Inc., at 35 Congress Street, Salem, Massachusetts, U.S.A., declare that the product described above is in conformity with ***EU EMC Directive 89/336/EEC Essential Health and Safety Requirements Relating to Electromagnetic Compatibility*** using the relevant sections of the following standards and other normative documents:

EN50082-1 (1997)

Generic Immunity Standard; Residential, Commercial, and Light Industrial Equipment

EN50082-2 (1995)

Generic Immunity Standard; Industrial, Scientific, and Medical Equipment

EN55011 (1991) Class B, Group 1

Radiated and Conducted Electronic Emissions for Industrial, Scientific, and Medical Equipment

EN55022 Class B (1995)

Radiated and Conducted Electromagnetic Emissions

EN61000-4-2 (1996)

Electrostatic Discharge Immunity

EN61000-4-3 (1997) / ENV 50204 (1996)

Radiated Electromagnetic Field Immunity

EN61000-4-4 (1995)

Electric Fast Transient Burst Immunity

EN61000-4-5 (1995)

Surge Immunity

EN61000-4-6 (1995)

Radio-Frequency Common Mode Immunity

EN61000-4-8 (1994)

Power-Frequency Magnetic Field Immunity

EN61000-4-11 (1994)

Voltage Dip and Interrupt Immunity

ENV5140 (1994)

Radiated Electromagnetic Field Immunity

This product also complies with **EU Low Voltage Directive 73/23/EEC** using the relevant sections of the following standards and other normative documents:

EN61010-1: 2001

Safety requirements for electrical equipment for measurement, controls and laboratory use.

This product has been manufactured in compliance with Excelitas Technologies Illumination, Inc. I.S. EN ISO 9001: 1994, Quality System, Registration Number M1312.

Stewart Tuttle, Quality Assurance