

PAX-10™

10-Watt Precision-Aligned Pulsed Xenon Light Source



Overview

The PAX-10™ by Excelitas is a Precision-Aligned Pulsed Xenon Light Sources offering a full 10 Watts of power. It's compact design integrates the flash lamp, trigger circuit, and power supply in an EMI-suppressant enclosure.

The PAX-10 features a pre-aligned arc position precisely located relative to a datum feature on the mounting surface of the case. This pre-aligned arc position allows for “plug and play” field replacement, eliminating alignment time and reducing OEMs’ costs and machine down time.

The PAX-10 utilizes Excelitas’ reliable pulsed Xenon flashlamp technology, delivering high radiant intensity over a continuous spectrum from the ultraviolet to the infrared. It provides a long life rating of over a billion flashes and is available in two arc orientations with user-selectable analog or digital intensity control.

The PAX family is the ideal pulsed Xenon light source for clinical diagnostics, invitro diagnostics, life sciences, drug discovery, proteomics, and analytical instrumentation applications.

PRODUCT NOTE

PAX Family of Precision-Aligned Xenon Light Sources

Features and Benefits

- Precision alignment-arc position precisely located (+/- 0.05 mm, 0.002 inches) relative to datum feature on the mounting surface
- Ease of installation and convenient “plug and play” field replacement
- 10 Watts average power
- Long life: >1.0 x 10⁹ flashes
- Spectral range from 120 to 2000+ nm
- Available in two arc orientations
- Integrated package—flash lamp, trigger circuit and power supply, all in a robust EMI suppressant enclosure
- Flexible mounting
- User selectable analog or digital intensity control
- CE Marked and RoHS compliant

Applications

- Absorption analysis
- Immunoassay modules
- Fluorimetry
- Spectroradiometry
- Liquid chromatography
- Colorimetry
- UV/VIS/NIR applications

Input Specifications

Parameter	Specification
Voltage	11-28 VDC
DC Current	2 A maximum
Inrush Current	4 A peak maximum
Trigger ¹	+5 V, 20-50 mA peak input, 10-100 μ s pulse width, leading edge trigger
Vref (Vo/Vref = 210)	1.9 to 4.76 VDC or 12 bit serial interface
Analog or digital control	External switch selectable
Internal/External Intensity Adjust	External switch selectable
Input Connector	9-pin D-sub

NOTE 1: Optically Isolated: Internal series resistor = 150 Ω

Part Number Configuration PAX-10AB-C*

A = Arc Orientation	0 - vertical 1 - horizontal
B = Lamp Type	1 - 1.5 mm arc length, 225 - 2000+ nm 2 - 1.5 mm arc length, 190 - 2000+ nm 3 - 1.5 mm arc length, 120 - 2000+ nm 4 - 3.0 mm arc length, 225 - 2000+ nm 5 - 3.0 mm arc length, 190 - 2000+ nm 6 - 3.0 mm arc length, 120 - 2000+ nm
C = Discharge Capacitor	1 - 0.10 μ F 2 - 0.15 μ F 3 - 0.22 μ F 4 - 0.33 μ F

*** Part Number Example:**
PAX-10 03-1 = vertical arc,
1.5 mm arc length with
120 nm cutoff and 0.10 μ F capacitor

Electrical Output

Parameter	Specification
Main Discharge Voltage	400-1000 VDC +/- 2%
Power	10 Watts
Standard Discharge Capacitors	0.10, 0.15, 0.22, 0.33 μ F
Flash Rate (Hz)	Fmax = 10/E where E = 1/2CV ²

Light Output

Parameter	Specification
Spectral Range	120-2000 + nm
Stability ²	< 1% CV
Life time	> 1 x 10 ⁹ Flashes

NOTE 2: Operating conditions: 0.33 μ F discharge capacitor. 1000 VDC discharge voltage. 10 Hz flash rate.

Environmental

Parameter	Specification
Operating temperature	0 to 40 °C
Storage temperature	-40 to 90 °C
Humidity	95% RH, non-condensing
Safety Compliance	CE Marked

Operating Conditions

Part Number	Main Discharge Capacitor (μ F)	Main Discharge Voltage (V)	Maximum Input Energy per Flash (mJ)	Maximum Repetition Rate (Hz)	Maximum Average Power (W)
PAX-10AB-1	0.10	400	8	1250	10
		600	18	556	
		1000	50	200	
PAX-10AB-2	0.15	400	12	833	10
		600	27	370	
		1000	75	133	
PAX-10AB-3	0.22	400	17.6	568	10
		600	39.6	252	
		1000	110	91	
PAX-10AB-4	0.33	400	26.4	378	10
		600	59.4	168	
		1000	165	60	

Characteristics

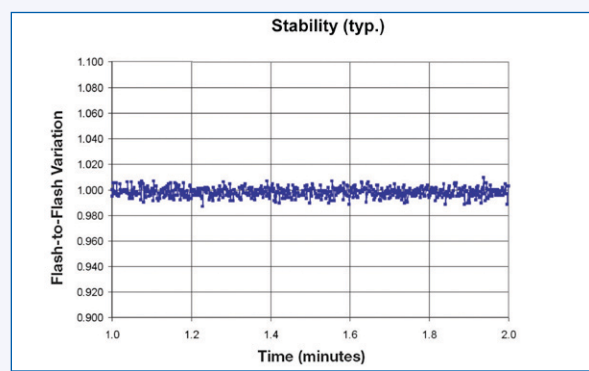
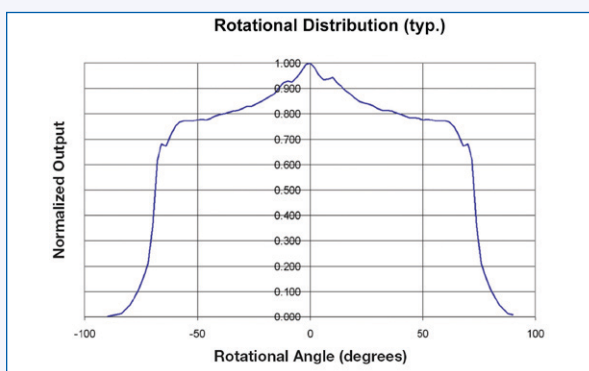
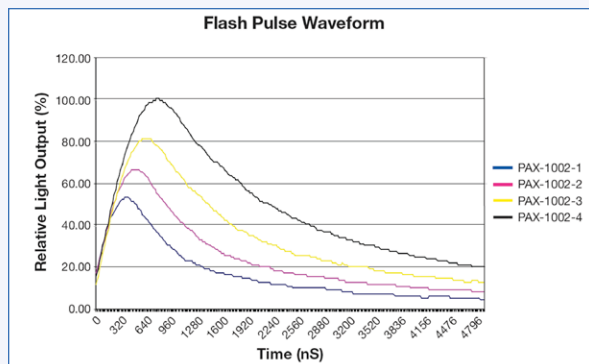
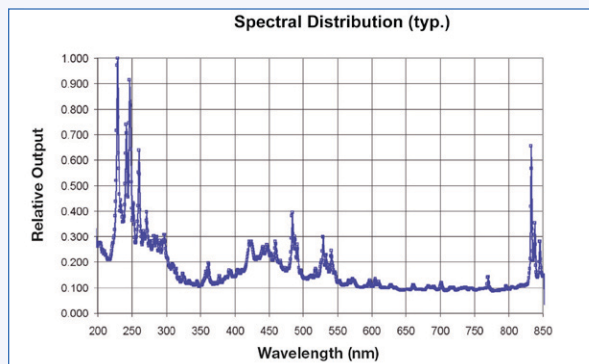

PAX-10 Precision Arc Alignment

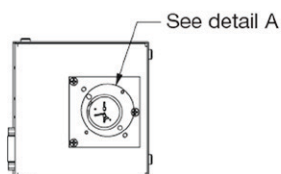

Arc position 0
PAX-100B-C

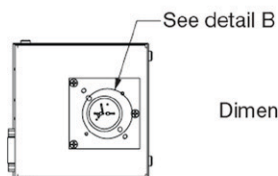
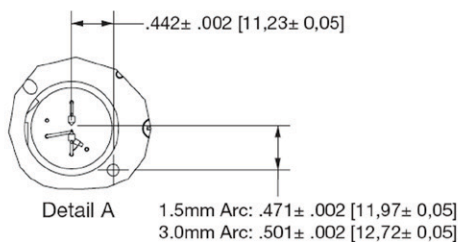

Arc position 1
PAX-101B-C

Dimensions: in [mm]

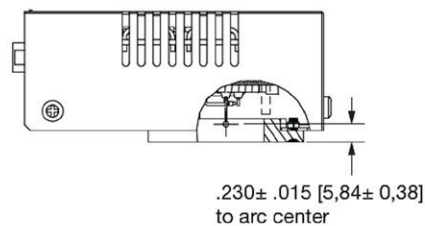
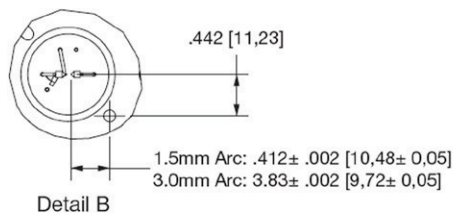

Notes

1. Precision mounting requires dowel pins (pin to protrude .150" ± .025, pin Ø.1250/.1255).
2. Mounting kit available as an accessory.
3. Alignment provided from pin center to theoretical intersection of electrode tip.

Mechanical Outline

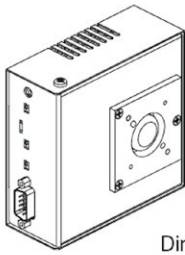

Dimensions: in [mm]

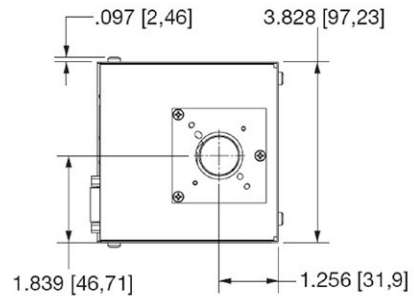
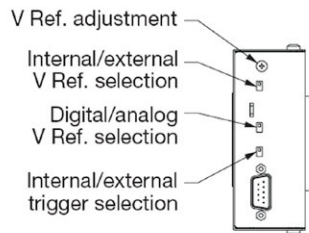
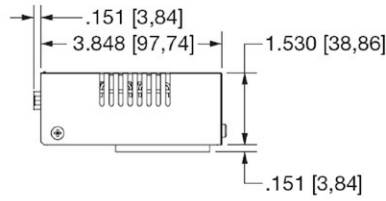

Mechanical Dimensions

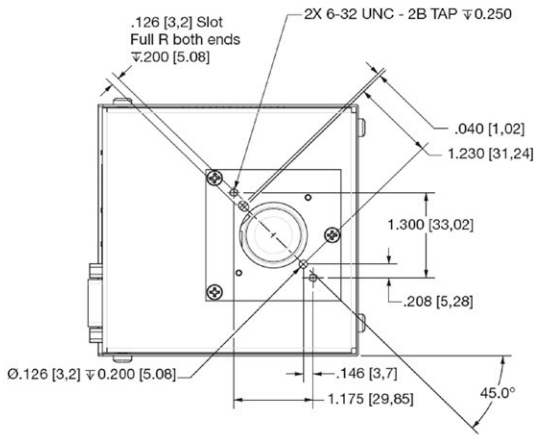

Ordering Information

Excelitas has designed an easy to use Evaluation Kit for testing the PAX-10 in your application.

To request additional information, receive a quote, or place an order for the PAX-10, please contact your Customer Support team or visit our website at www.excelitas.com.

All values are nominal; specifications are subject to change without notice.

Excelitas Technologies
35 Congress Street
Salem, Massachusetts 01970 USA
Telephone: (+1) 978.745.3200
Toll free: (+1) 800.950.3441
Fax: (+1) 978.745.0894
generalinquiries@excelitas.com
www.excelitas.com

**Excelitas Technologies
GmbH & Co. KG**
Wenzel-Jaksch-Str. 31
D-65199 Wiesbaden
Germany
Telephone: (+49) 611 492 430
Fax: (+49) 611 492 165

**Asia Headquarters
Excelitas Technologies**
47 Ayer Rajah Crescent #06-12
Singapore 139947
Telephone: (+65) 6775-2022
Fax: (+65) 6775-1008

EXCELITAS
TECHNOLOGIES

For a complete listing of our global offices, visit www.excelitas.com/ContactUs

Copyright ©2011 Excelitas Technologies Corp. All rights reserved. Excelitas® is a registered trademark of Excelitas Technologies Corp. All other trademarks are the property of their respective owners. Excelitas reserves the right to change this document at any time without notice and disclaims liability for editorial, pictorial or typographical errors.