

## **C30884EH**

### **Silicon Avalanche Photodiode With Very High Modulation Capability**



The C30884EH is a silicon avalanche photodiode having high responsivity and fast rise and fall times. Because the fall time characteristic has no “tail”, the responsivity of the device is independent of modulation frequency up to about 400 MHz.

This device is made using a double-diffused “reach-through” structure and is optimized for high responsivity at wavelengths of below 1000 nanometers.

The C30884EH is hermetically sealed behind a flat glass window in a modified low-profile TO-5 package.

The fast time response characteristics and high responsivity of this device make it highly useful in a wide variety of applications including optical communications, laser range finding and high-speed switching systems.

#### **Key Features**

- High Quantum Efficiency –  
85% typical at 900 nm  
10% typical at 1060nm
- Spectral Response Range–  
(10% Points) 400 to 1100 nm
- Fast Time Response –  
Rise time typically 1 ns  
Fall time typically 1 ns
- Wide operating Temperature  
Range –  
-40°C to 70°C
- Hermetically Sealed Low-  
Profile TO-5 package

#### **Applications**

- Optical Communications
- Laser Range Finding
- High Speed Switching Systems

## Photodiode C30884E series

### Silicon Avalanche Photodiode With Very High Modulation Capability

**Table 1 – Mechanical and Optical Characteristics**

Parameter	Symbol		Unit	Remarks/Conditions
Photosensitive Surface:				
Useful area	A	0.5	mm <sup>2</sup>	Shape : Circular
Useful diameter	d	0.8	mm	
Field of View:				
Nominal field of view $\alpha$ (See Figure 7)	FoV	119	Degrees	
Nominal field of view $\alpha'$ (See Figure 7)		132		

**Table 2 – Electro-Optical Characteristics**

Test conditions: Case Temperature  $T_A = 22\text{ }^\circ\text{C}$ ; at the DC reverse operating voltage  $V_r$ ,  $V_{op}$  supplied with the device<sup>3</sup>

Parameter	Symbol	Minimum	Typical	Maximum	Unit
Breakdown Voltage	$V_{br}$	190		290	V
Operating Voltage	$V_{op}$	180		260	V
Temperature Coefficient of $V_{op}$ for Constant Gain <sup>1</sup>	$V_{op}$		1.1		V/ $^\circ\text{C}$
Gain	M		100		
Responsivity					
at 900 nm	R	55	63		A/W
at 1060 nm		6	8		
Quantum Efficiency					
at 900 nm	Q.E.		85		%
at 1060 nm			10		
Dark Current <sup>2</sup>	$I_d$			75	nA
Noise Current $f=10\text{kHz}$ , $\Delta f=1.0\text{Hz}$	$i_n$			1	pA/sqrt(Hz)
Rise/Fall Time, $R_L = 50\Omega$ :					
10% to 90% points	$t_r$		1	1.5	ns
90% to 10% points	$t_f$		1	1.5	
Capacitance	$C_d$		4	6	pF
Series Resistance				15	$\Omega$
Storage Temperature	$T_{stg}$	-60		100	$^\circ\text{C}$
Operating Temperature	$T_o$	-40		70	$^\circ\text{C}$

<sup>1</sup> For  $V_{br}$  at other temperatures, see Figures 2 and 3.

<sup>2</sup> See Figure 4.

<sup>3</sup> Each individual APD is supplied with its own test data at shipment

## Photodiode C30884E series

### Silicon Avalanche Photodiode With Very High Modulation Capability

Table 3 – Maximum Ratings, Absolute Maximum Values

Parameter	Symbol	Maximum	Unit	Remarks/Conditions
Reverse Bias Dark Current		100	$\mu\text{A}$	
Photocurrent average value peak value	$i_p$	500 2	$\mu\text{A}$ mA	For 1 second duration, non-repetitive.
Forward Current average value peak value	$I_F$	5 50	mA	For 1 second duration, non-repetitive.
Total power		0.1	W	Dissipation at 22°C

Figure 1 – Typical Spectral Responsivity Characteristics at a Gain of 100

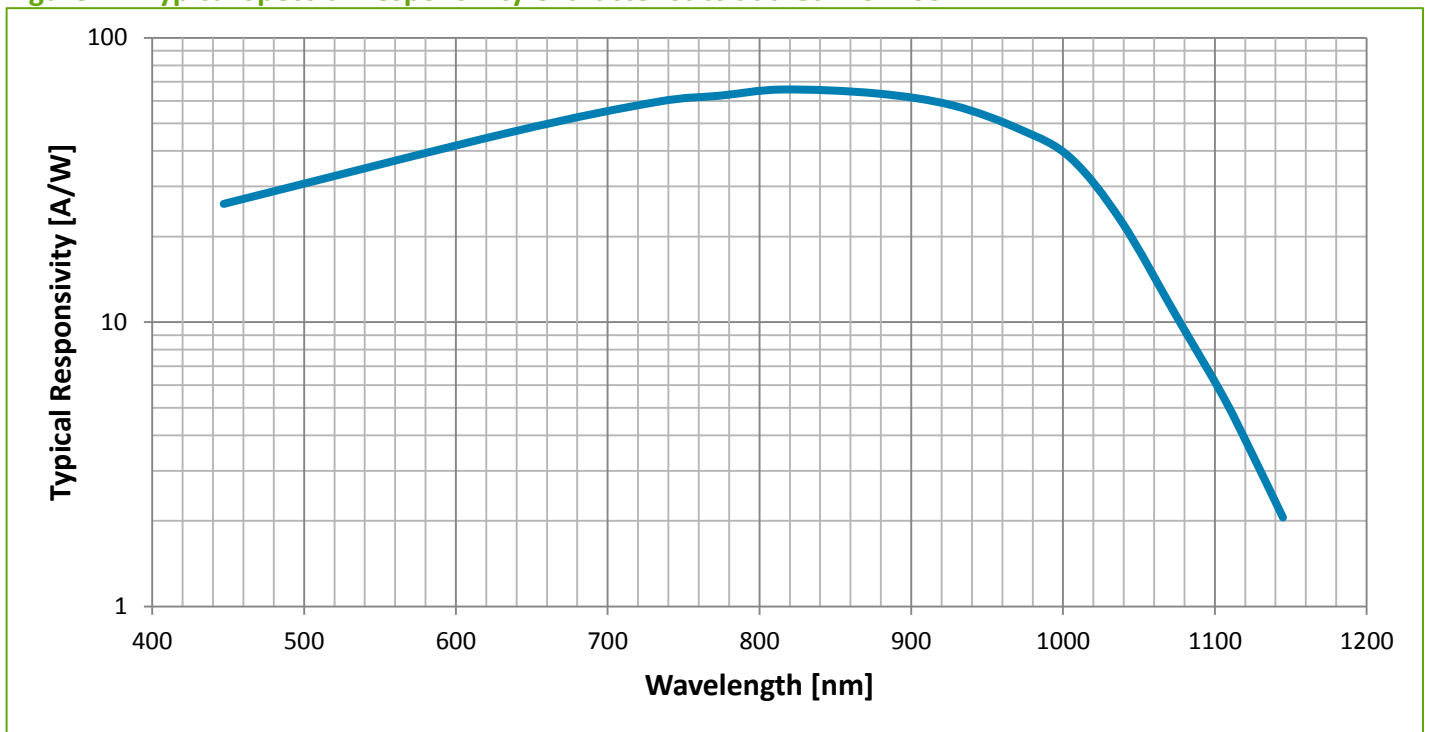

Silicon Avalanche Photodiode With Very High Modulation Capability

Figure 2 – Typical Responsivity at 900 nm as a function of Operating Voltage,  $V_{op}$

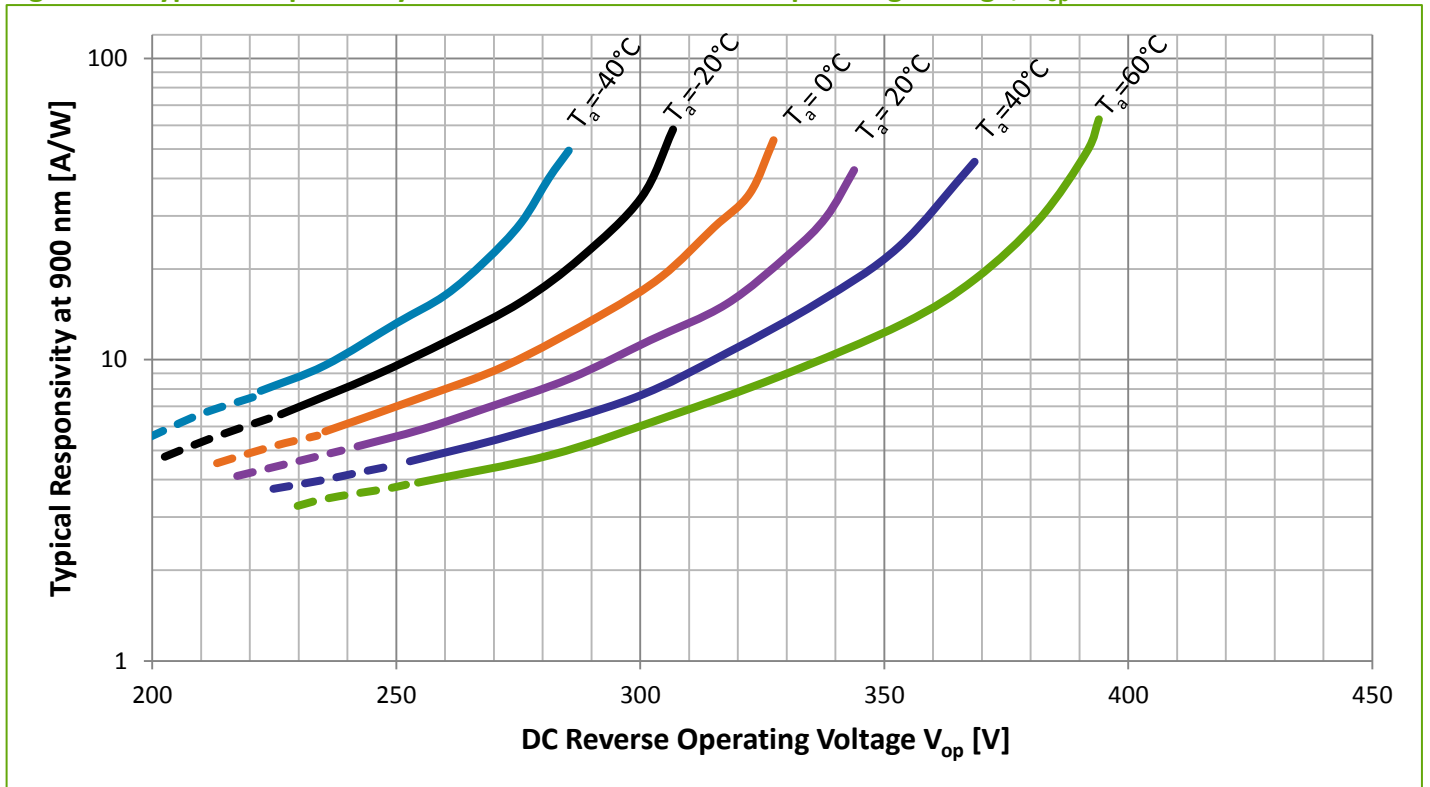
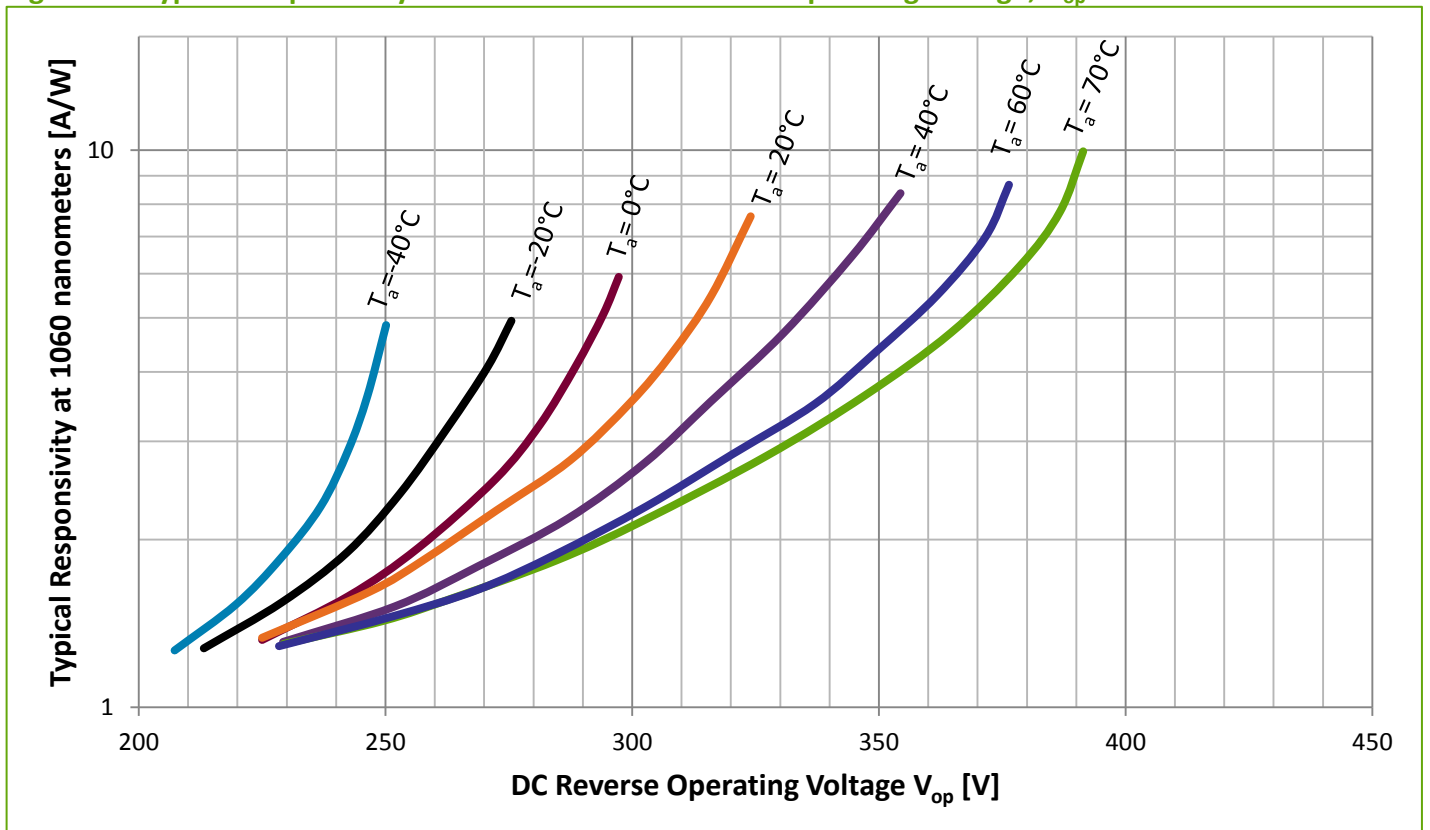

Figure 3 – Typical Responsivity at 1060 nm as a function of Operating Voltage,  $V_{op}$



Silicon Avalanche Photodiode With Very High Modulation Capability

Figure 4 – Typical Dark Current as a function of Operating Voltage,  $V_{op}$

Test conditions: Case temperature = 22°C

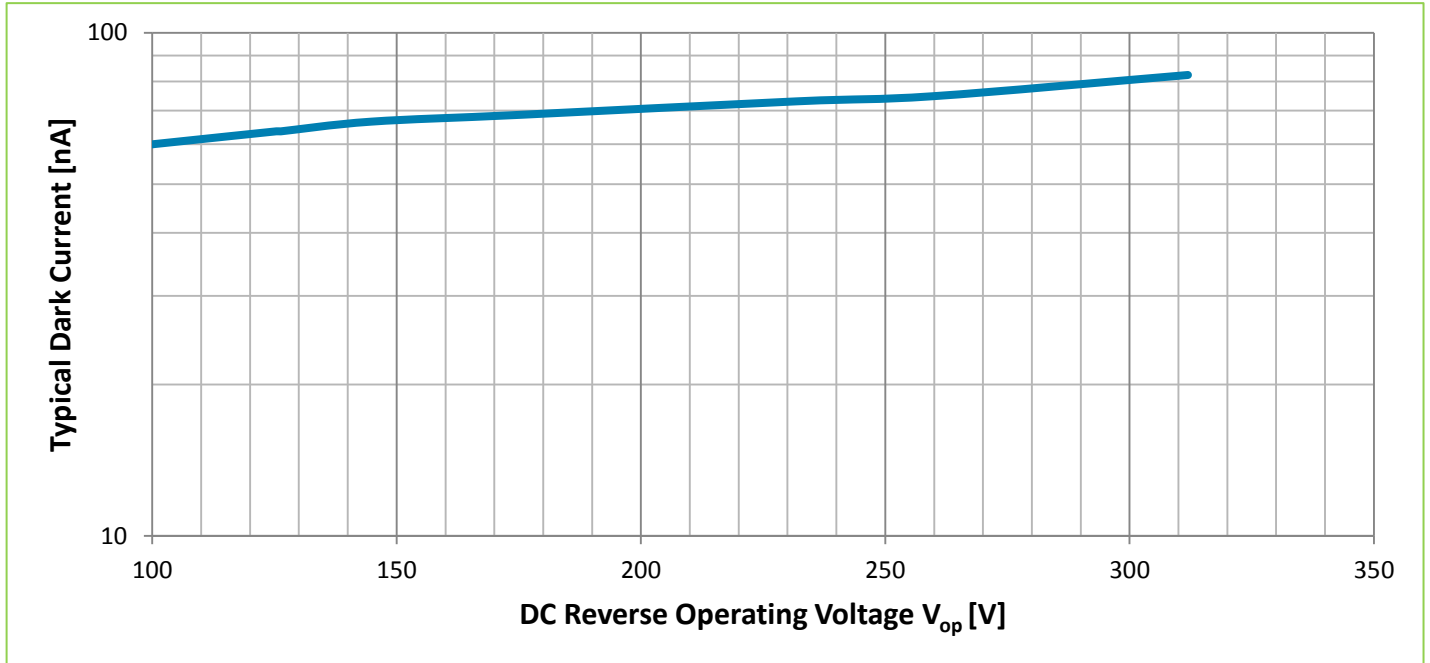
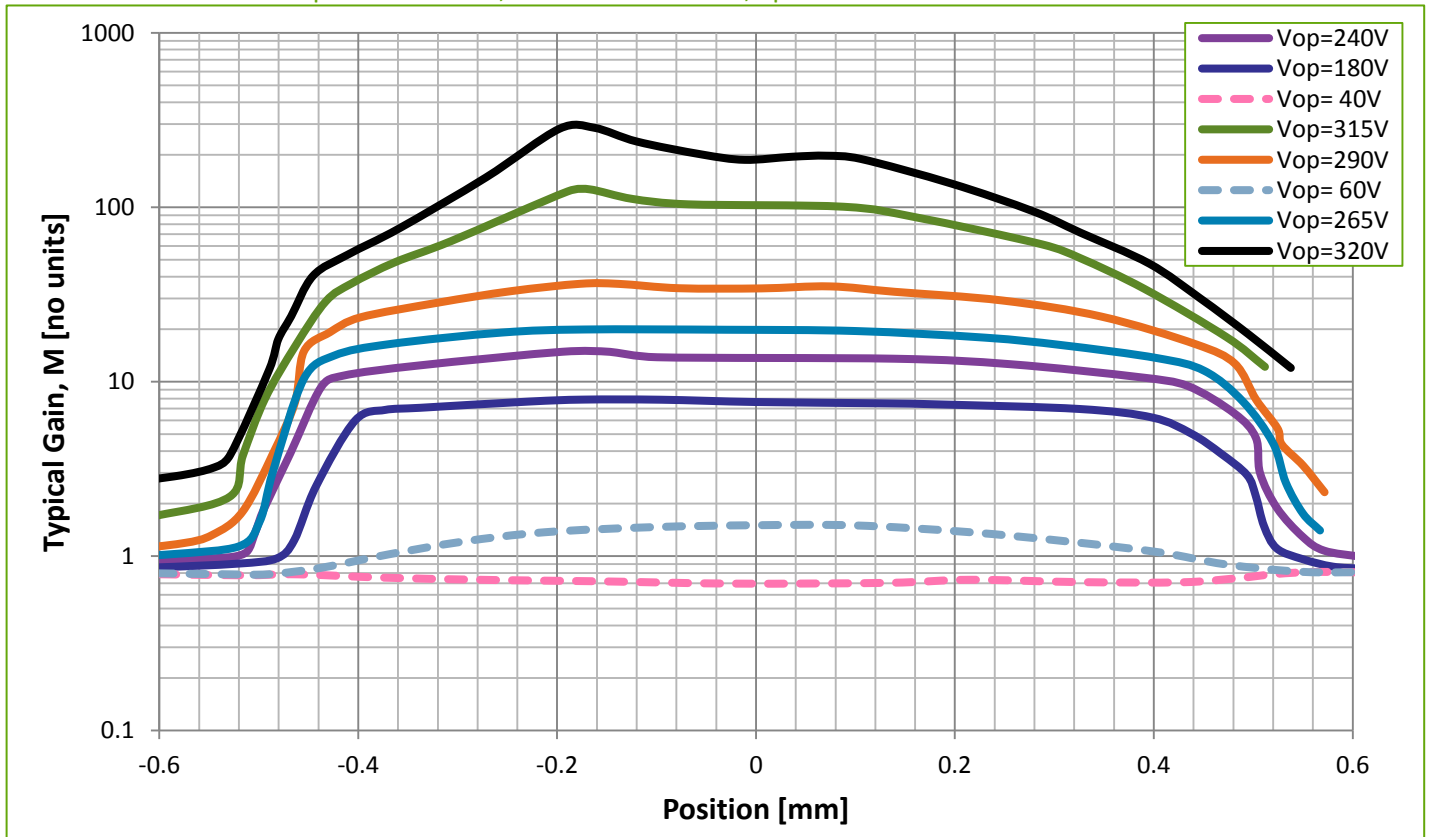

Figure 5 – Typical Gain as a function of Light Spot Position

Test conditions: Case temperature = 22°C, Detector center = 0, Spot diameter = 0.0254 mm



## Silicon Avalanche Photodiode With Very High Modulation Capability

Figure 6 – Approximate field of view

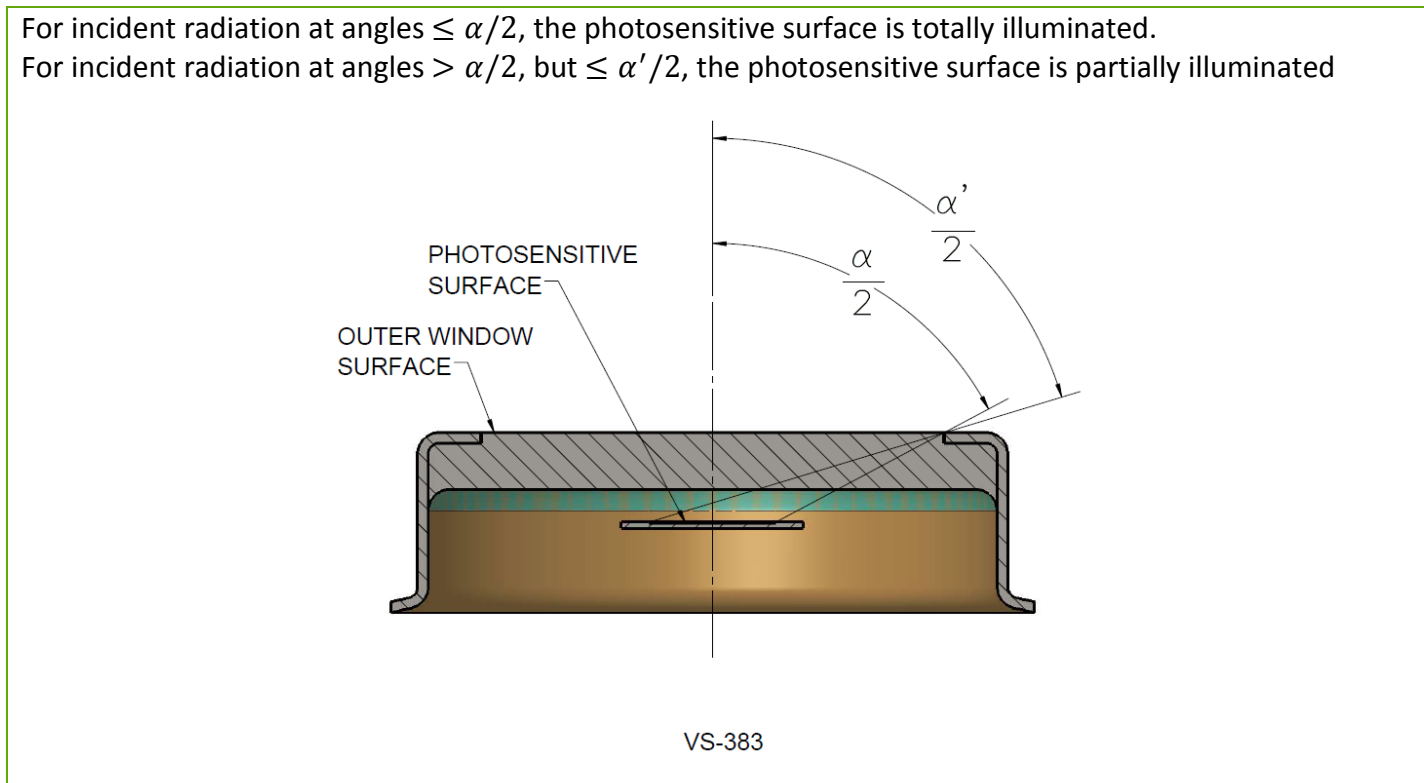
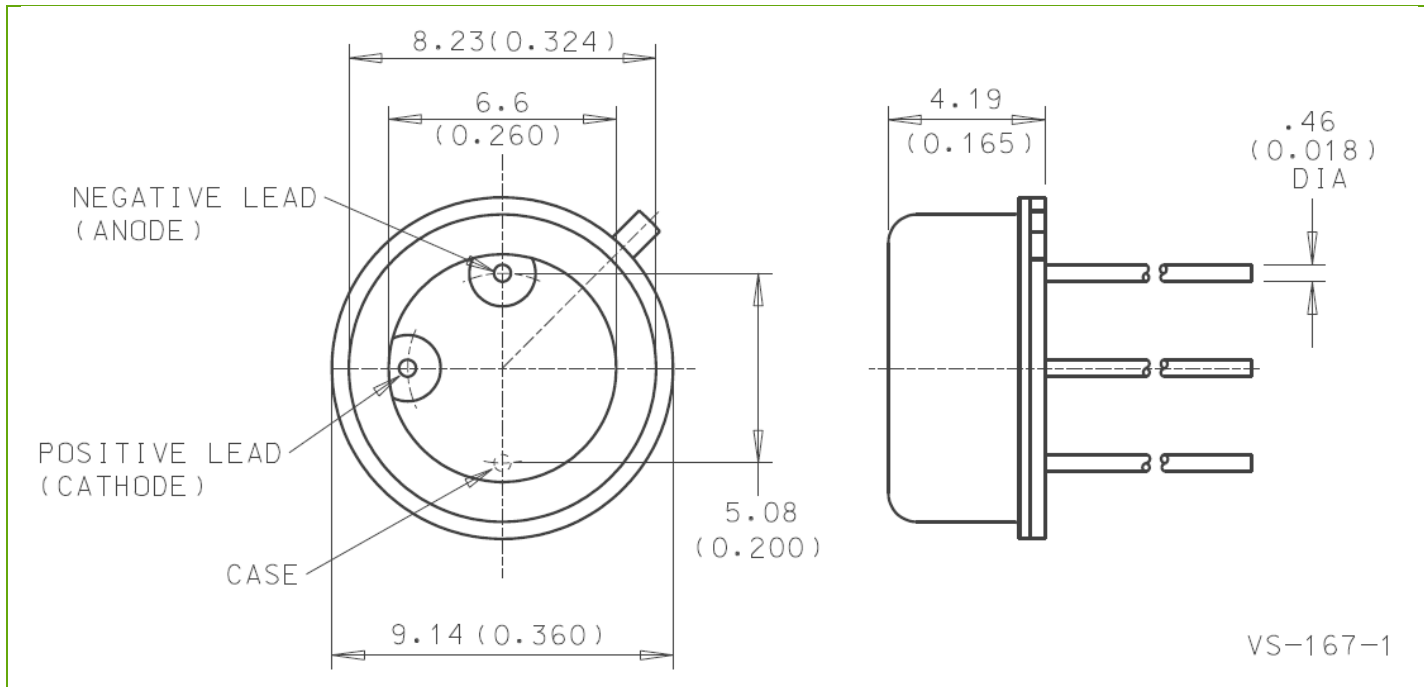

Figure 7 – Dimensional Outline



## Photodiode C30884E series

### Silicon Avalanche Photodiode With Very High Modulation Capability

#### RoHS Compliance

The C30884EH is designed and built to be fully compliant with the European Union Directive 2011/65/EU – Restriction of the use of certain Hazardous Substances (RoHS) in Electrical and Electronic equipment.



#### Warranty

A standard 12-month warranty following shipment applies. Any warranty is null and void if the photodiode window has been opened.

#### About Excelitas Technologies

Excelitas Technologies is a global technology leader focused on delivering innovative, customized solutions to meet the lighting, detection and other high-performance technology needs of OEM customers.

Excelitas has a long and rich history of serving our OEM customer base with optoelectronic sensors and modules for more than 45 years beginning with PerkinElmer, EG&G, and RCA. The constant throughout has been our innovation and commitment to delivering the highest quality solutions to our customers worldwide.

From analytical instrumentation to clinical diagnostics, medical, industrial, safety and security, and aerospace and defense applications, Excelitas Technologies is committed to enabling our customers' success in their specialty end-markets. Excelitas Technologies has approximately 5,000 employees in North America, Europe and Asia, serving customers across the world.

**Excelitas Technologies**  
22001 Dumberry Road  
Vaudreuil-Dorion, Quebec  
Canada J7V 8P7  
Telephone: (+1) 450 424 3300  
Toll-free: (+1) 800 775 6786  
Fax: (+1) 450 424 3345  
[detection@excelitas.com](mailto:detection@excelitas.com)

**Excelitas Technologies  
GmbH & Co. KG**  
Wenzel-Jaksch-Str. 31  
D-65199 Wiesbaden  
Germany  
Telephone: (+49) 611 492 430  
Fax: (+49) 611 492 165  
[detection.europe@excelitas.com](mailto:detection.europe@excelitas.com)

**Excelitas Technologies Singapore, Pte. Ltd.**  
8 Tractor Road  
Singapore 627969  
Telephone: (+65) 6775 2022 (Main number)  
Telephone: (+65) 6770 4366 (Customer Service)  
Fax: (+65) 6778-1752  
[detection.asia@excelitas.com](mailto:detection.asia@excelitas.com)



For a complete listing of our global offices, visit [www.excelitas.com/locations](http://www.excelitas.com/locations)

© 2016 Excelitas Technologies Corp. All rights reserved. The Excelitas logo and design are registered trademarks of Excelitas Technologies Corp. All other trademarks not owned by Excelitas Technologies or its subsidiaries that are depicted herein are the property of their respective owners. Excelitas reserves the right to change this document at any time without notice and disclaims liability for editorial, pictorial or typographical errors.